

- de** Montageanleitung
- en** Mounting instructions
- fr** Instructions de montage
- sv** Monteringsinstruktion
- nl** Montage-aanwijzing
- it** Istruzioni di montaggio
- fi** Asennusohje
- es** Instrucciones de montaje
- da** Monteringsvejledning
- pl** Instrukcja montażu
- cz** Montážní návod
- el** Οδηγίες εγκατάστασης
- ru** Инструкция по установке
- zh** 安裝指導

- Kugelhahn**
- Ball valve**
- Vanne à boisseau sphérique**
- Kulventilen**
- Kogelafsluiter**
- Valvola a sfera**
- Palloventtiilin**
- Válvula de bola**
- Kulventil**
- Zawory kulowe regulacyjne**
- Regulační kulové kohouty**
- Δίοδες σφαιρικές βάνες**
- Шаровые клапаны**
- 电动球阀**

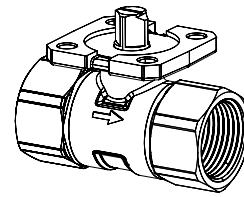

VAI60..

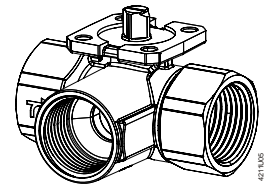

VBI60..

VAI60..
VBI60..L
VBI60..T

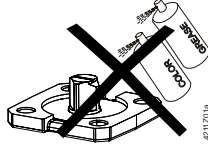
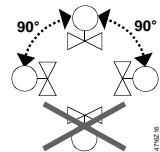

1

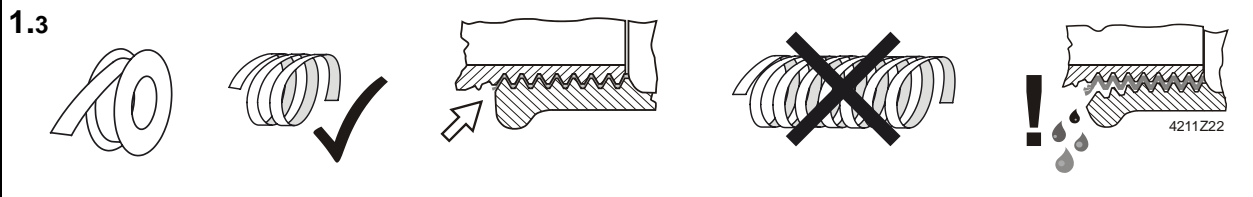
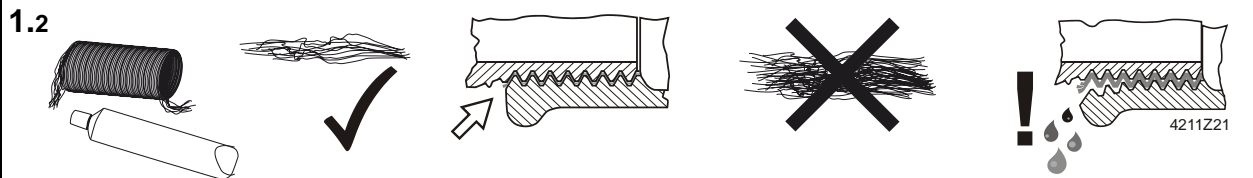
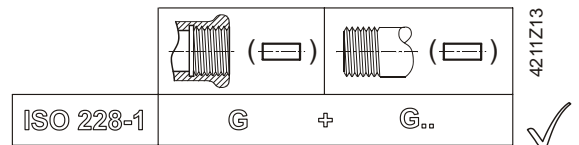
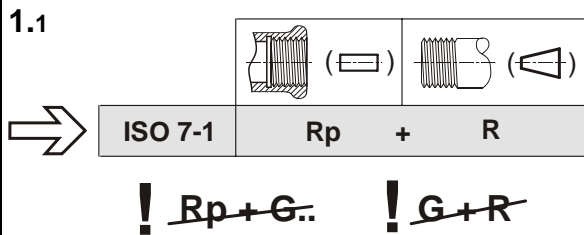

4211Z20

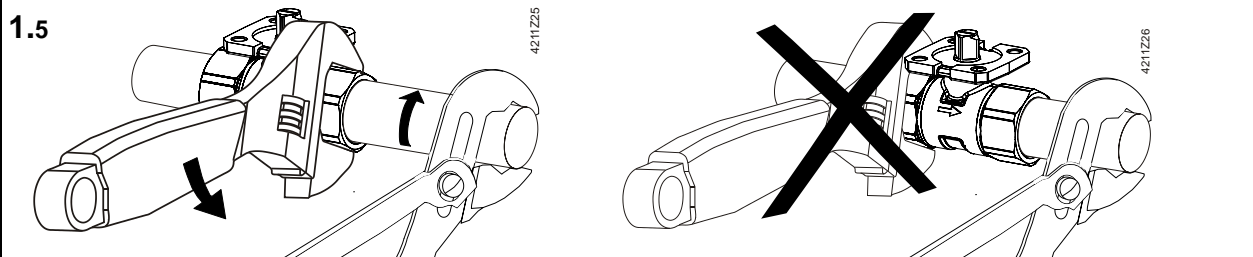
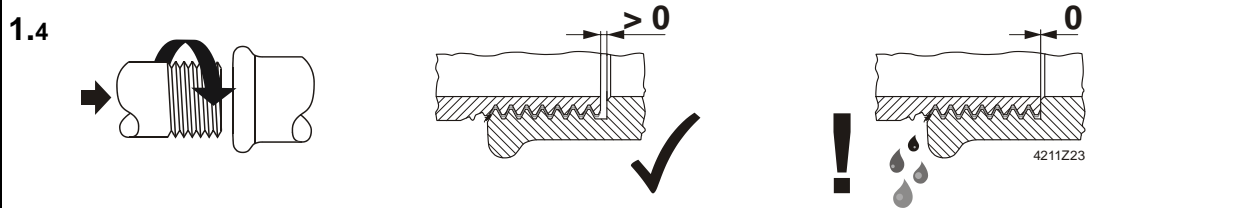

2

2.1 VAI60..

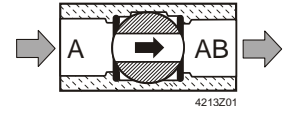
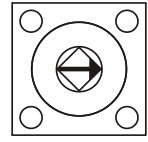
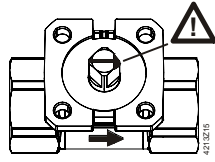
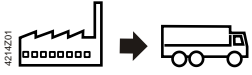

$$A - AB = 100 \%$$

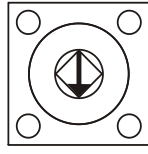
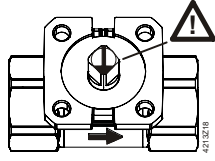
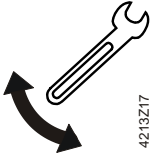

$$A - AB = 0 \%$$

2.2 VBI60..L

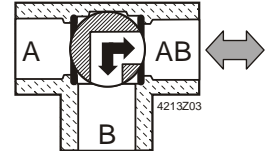
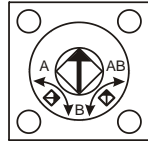
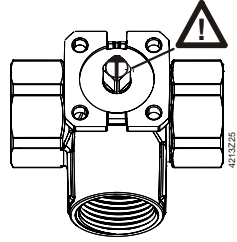
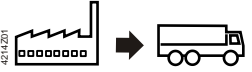

$$B - AB (AB - B) = 100 \%$$

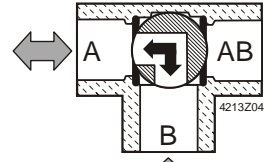
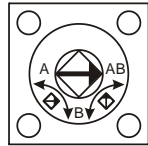
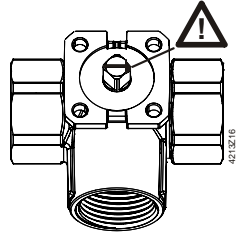

$$A - B (B - A) = 100 \%$$

2.3 VBI60..T

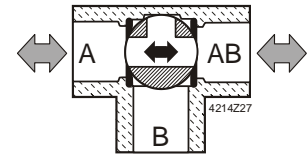
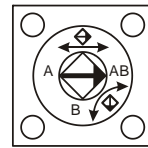
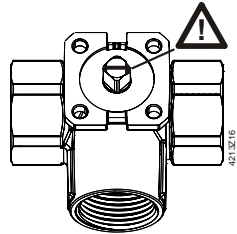
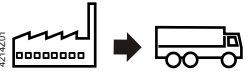

$$A - AB (AB - A) = 100 \%$$

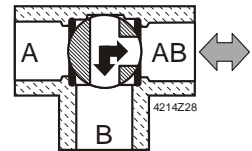
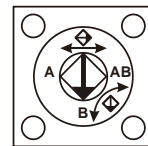
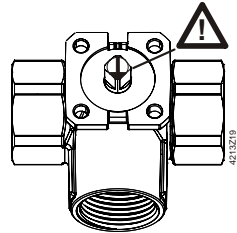

$$B - AB (AB - B) = 100 \%$$

3

VAI60..

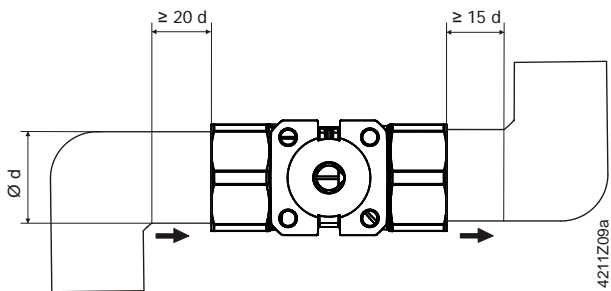

4211Z08a

VBI60..

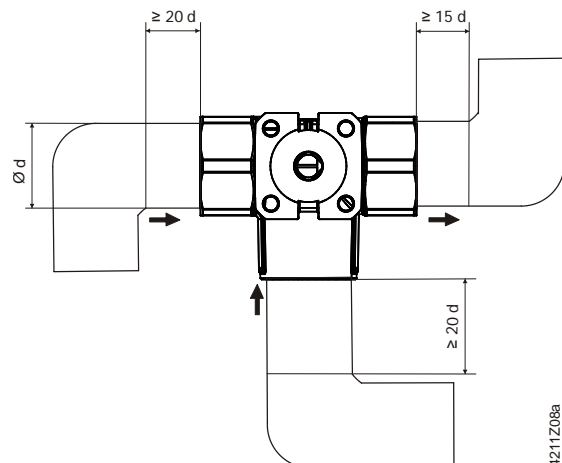

4211Z08a

4

VAI60..

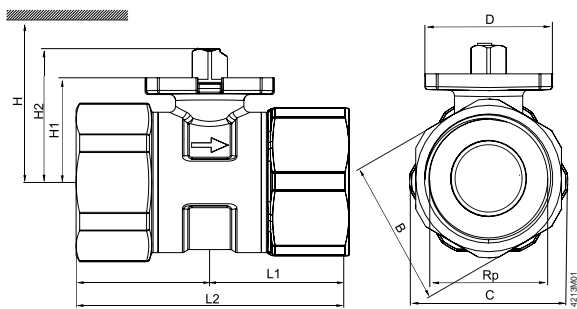

VBI60..

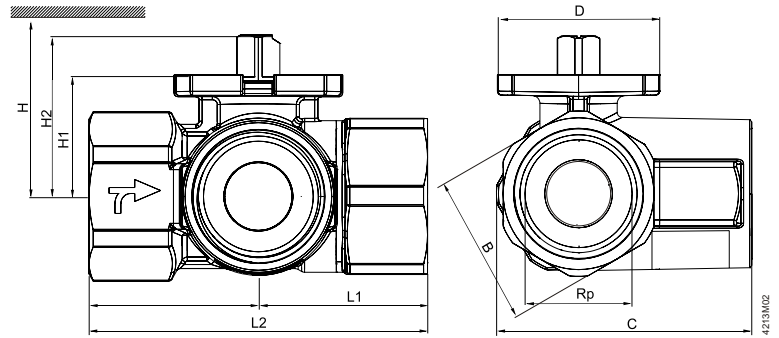

VAI60..	DN	B [mm]	C [mm]	D [mm]	Rp [Zoll]	L1 [mm]	L2 [mm]	H1 [mm]	H2 [mm]	H				[kg]
										GSD..9A [mm]	GQD..9A [mm]	GMA..9E [mm]	GLB..9E [mm]	
VAI60.15-15	15	26	31 ¹⁾	42	Rp ½	30.8	61.6	27.6	37.6	> 300	> 300	> 300	> 300	0.28
VAI60.20-22	20	31	38	42	Rp ¾	33.5	67	30.5	40.5	> 300	> 300	> 300	> 300	0.36
VAI60.25-22	25	39	42.5	42	Rp 1	38.4	76.8	30.5	40.5	> 320	> 320	> 320	> 320	0.46
VAI60.32-35	32	48	52	42	Rp 1 ¼	44	88	34.3	44.3					
VAI60.40-68	40	55	61	42	Rp 1 ½	50.9	101.8	39.8	49.8					1.1
VAI60.50-96	50	67	74	42	Rp 2	58.1	116.2	52.8	62.8			> 335	> 335	1.74

VBI60..L	DN	B [mm]	C [mm]	D [mm]	Rp [mm]	L1 [mm]	L2 [mm]	H1 [mm]	H2 [mm]	H				[kg]
										GSD..9A [mm]	GQD..9A [mm]	GMA..9E [mm]	GLB..9E [mm]	
VBI60.15-5L	15	26	49.5	42	Rp ½	33.3	66.6	27.6	37.6	> 300	> 300	> 300	> 300	0.32
VBI60.20-9L	20	39	61.05	42	Rp ¾	40.2	80.4	30.5	40.5	> 300	> 300	> 300	> 300	0.73
VBI60.25-9L	25	39	66.5	42	Rp 1	42.7	85.4	30.5	40.5	> 320	> 320	> 320	> 320	0.62
VBI60.32-13L	32	48	78.6	42	Rp 1 ¼	49.6	99.2	34.3	44.3					
VBI60.40-25L	40	55	87.6	42	Rp 1 ½	54.8	109.6	39.8	49.8					1.43
VBI60.50-37L	50	67	105.9	42	Rp 2	65.7	131.4	52.8	62.8			> 335	> 335	2.36

VBI60..T														
VBI60..T	DN	B [mm]	C [mm]	D [mm]	Rp [mm]	L1 [mm]	L2 [mm]	H1 [mm]	H2 [mm]	H				[kg]
										GSD..9A [mm]	GQD..9A [mm]	GMA..9E [mm]	GLB..9E [mm]	
VBI60.15-12T	15	26	49.5	42	Rp ½	33.3	66.6	27.6	37.6	> 300	> 300	> 300	> 300	0.31
VBI60.20-16T	20	39	61.05	42	Rp ¾	40.2	80.4	30.5	40.5	> 300	> 300	> 300	> 300	0.74
VBI60.25-16T	25	39	66.5	42	Rp 1	42.7	85.4	30.5	40.5	> 320	> 320	> 320	> 320	0.63
VBI60.32-25T	32	48	78.6	42	Rp 1 ¼	49.6	99.2	34.3	44.3					
VBI60.40-49T	40	55	87.6	42	Rp 1 ½	54.8	109.6	39.8	49.8					1.38
VBI60.50-73T	50	67	105.9	42	Rp 2	65.7	131.4	52.8	62.8			> 335	> 335	2.26

5

VAI60.. + ALI..VAI..

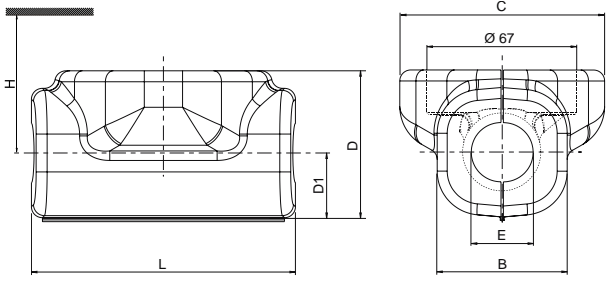

VBI60.. + ALI..VBI..

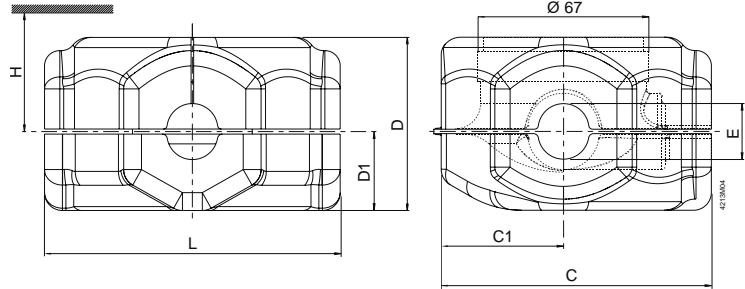

VAI60.. + ALI..VAI..		DN	B [mm]	C [mm]	D [mm]	D1 [mm]	E [mm]	L [mm]	GSD..9A [mm]	GQD..9A [mm]	H		ALI.. [g]
											GMA..9E [mm]	GLB..9E [mm]	
VAI60.15-15	ALI15VAI60/61	15	56	95	65	27	21	100	> 300	> 300	> 300	> 300	15
VAI60.20-22	ALI20VAI60/61	20	56	95	66	32	27	105					16
VAI60.25-22	ALI25VAI60/61	25	56	95	80	37	34	108	> 320	> 320	> 320	> 320	20
VAI60.32-35	ALI32VAI60/61	32	86	100	95	47	43	130					28
VAI60.40-68	ALI40VAI60/61	40	95	102	98	50	48	140					32
VAI60.50-96	ALI50VAI60/61	50	105	96	110	56	61	160			> 335	> 335	36

VBI60.. + ALI..VBI..		DN	C [mm]	C1 [mm]	D [mm]	D1 [mm]	E [mm]	L [mm]	GSD..9A [mm]	GQD..9A [mm]	H		ALI.. [g]
											GMA..9E [mm]	GLB..9E [mm]	
VBI60.15..	ALI15VBI60/61	15	100	50	70	34	21	100	> 300	> 300	> 300	> 300	21
VBI60.20..	ALI20VBI60	20	115	55	80	40	27	120					30
VBI60.25..	ALI25VBI60/61	25	115	55	80	40	34	120	> 320	> 320	> 320	> 320	30
VBI60.32..	ALI32VBI60/61	32	125	55	95	45	43	150					41
VBI60.40..	ALI40VBI60/61	40	125	55	95	45	48	150					43
VBI60.50..	ALI50VBI60/61	50	145	60	110	54	61	170			> 335	> 335	51