

- de** Montageanleitung
- en** Mounting instructions
- fr** Instructions de montage
- sv** Monteringsinstruktion
- nl** Montage-aanwijzing
- it** Istruzioni di montaggio
- fi** Asennusohje
- es** Instrucciones de montaje
- da** Monteringsvejledning
- pl** Instrukcja montażu
- cz** Montážní návod
- el** Οδηγίες εγκατάστασης
- ru** Инструкция по установке
- zh** 安裝指導

- Kugelhahn**
- Ball valve**
- Vanne à boisseau sphérique**
- Kulventilen**
- Kogelafsluiter**
- Valvola a sfera**
- Palloventtiiliin**
- Válvula de bola**
- Kulventil**
- Zawory kulowe regulacyjne**
- Regulační kulové kohouty**
- Δίοδες σφαιρικές βάνες**
- Шаровые клапаны**
- 电动球阀**

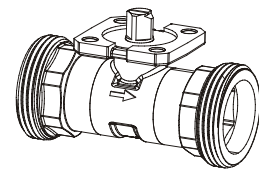

VAG61..

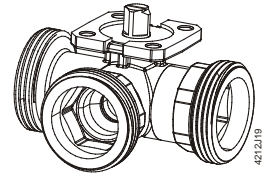

VBG61..

VAG61..
VBG61..

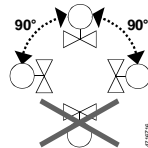

1

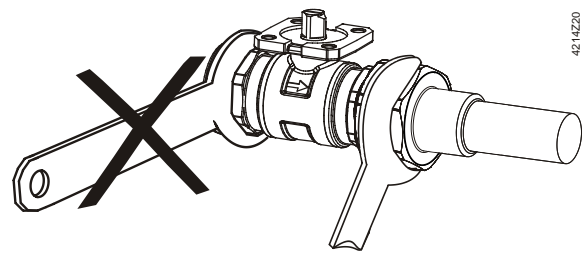
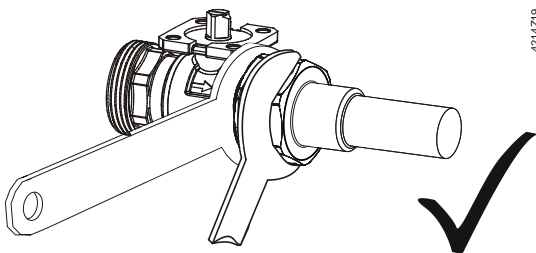

2

2.1 VAG61..

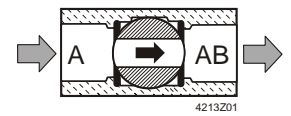
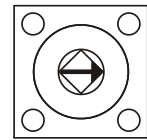
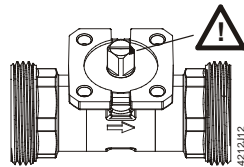

A – AB = 100 %

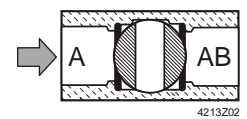
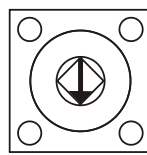
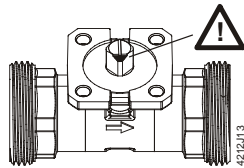

A – AB = 0 %

2.1 VBG61..

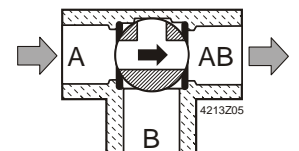
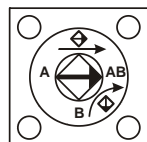
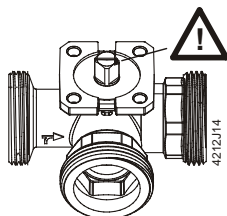

A – AB = 100 %

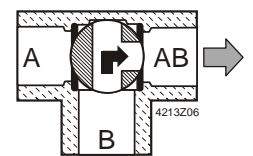
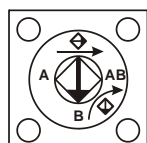
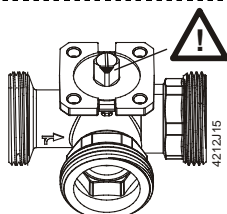

B – AB = 100 %

3 VAG61..

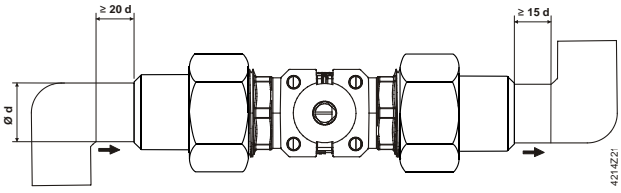

VBG61..

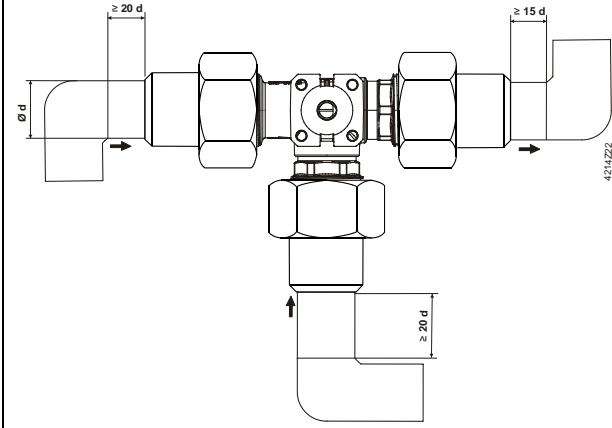

4

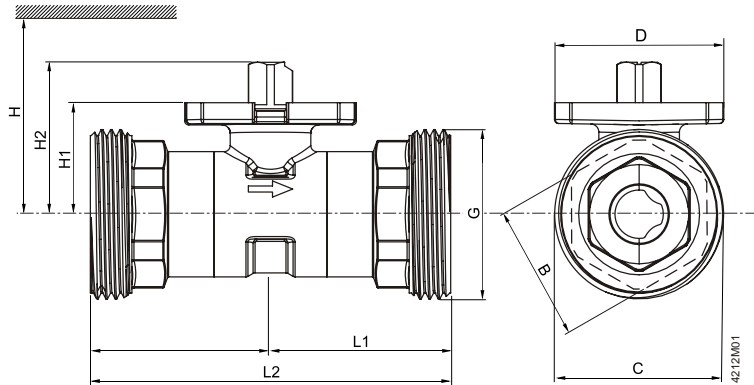

VAG61..	DN	B [mm]	C [mm]	D [mm]	G [Inch]	L1 [mm]	L2 [mm]	H1 [mm]	H2 [mm]	H				kg
										GQD..9A [mm]	GDB..9E [mm]	GMA..9E [mm]	GLB..9E [mm]	
VAG61.15..	15	27	33	42	G 1B	43.5	87	27.6	37.6	> 300	> 300	> 300	> 300	0.36
VAG61.20..	20	34	42	42	G 1 1/4B	44.7	89.4	27.6	37.6					0.44
VAG61.25..	25	35	48	42	G 1 1/2B	44.7	89.4	30.5	40.5	> 320	> 320	> 320	> 320	0.57
VAG61.32..	32	38	59.7	42	G 2B	50.1	100.2	34.3	44.3					0.84
VAG61.40..	40	49	65.7	42	G 2 1/4B	58.3	116.6	39.8	49.8	> 335	> 335	> 335	> 335	1.29
VAG61.50..	50	61	81.6	42	G 2 3/4B	62	124	52.8	62.8					1.98

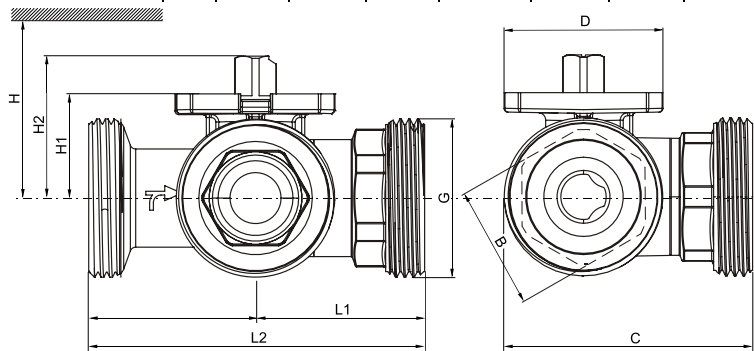

VBG61..	DN	B [mm]	C [mm]	D [mm]	G [Inch]	L1 [mm]	L2 [mm]	H1 [mm]	H2 [mm]	H				kg
										GQD..9A [mm]	GDB..9E [mm]	GMA..9E [mm]	GLB..9E [mm]	
VBG61.15..	15	27	59.5	42	G 1B	43.5	87	24.2	33.7	> 300	> 300	> 300	> 300	0.41
VBG61.15-6.3		27	61	42	G 1B	44.3	88.6	27.6	37.6					0.45
VBG61.20..	20	34	66	42	G 1 1/4B	44.7	89.4	27.6	37.6	> 320	> 320	> 320	> 320	0.52
VBG61.25..	25	35	73	42	G 1 1/2B	49.2	98.4	30.5	40.5					0.75
VBG61.32..	32	38	94	42	G 2B	57	114	34.3	44.3	> 335	> 335	> 335	> 335	1.2
VBG61.40..	40	49	107	42	G 2 1/4B	63.8	127.6	39.8	49.8					1.84
VBG61.50..	50	61	123	42	G 2 3/4B	69	138	52.8	62.8	> 335	> 335	> 335	> 335	2.83