

# SIEMENS

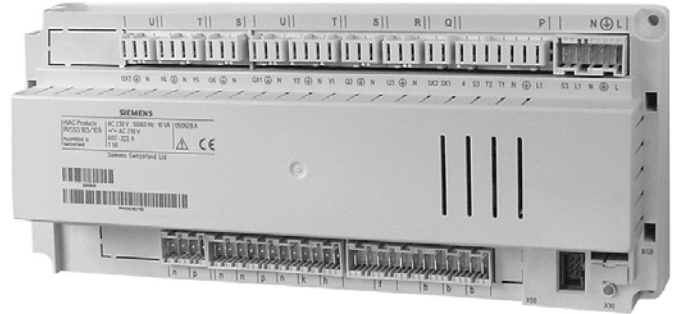
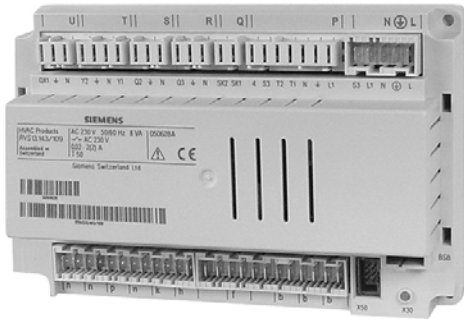

## Albatros<sup>2</sup> Zone controller User Manual

**RVS46..**  
**AVS75..**  
**AVS37..**  
**QAA75..**  
**QAA78..**  
**QAA55..**

Edition 3.0

CE1U2353en  
02.06.2009

Building Technologies  
HVAC Products



# Contents

1	Overview.....	9
1.1	Product range overview.....	10
1.1.1	Topology.....	10
	Wired.....	10
	Wireless.....	10
1.1.2	Operating options.....	11
2	Safety notes.....	12
2.1	Product liability.....	12
3	Mounting and installation.....	13
3.1	Regulations.....	13
	Electrical installation.....	13
3.2	Basic units RVS.....	13
	Planning.....	13
	Mounting method.....	14
	Dimensions and drilling plan.....	14
3.2.1	RVS46.530 connection terminals.....	15
3.2.2	RVS46.543 connection terminals.....	15
	Terminal markings.....	16
3.3	Extension module AVS75.390.....	17
	Dimensions and drilling plan.....	17
3.3.1	AVS75.390 connection terminals.....	17
	Terminal markings.....	18
	Assignment of terminals.....	18
3.4	Operator unit AVS37.294.....	19
	Mounting method.....	19
	Connections.....	19
	Ground.....	19
3.5	Operator unit AVS37.390.....	20
	Connections.....	20
	Dimensions.....	20
3.6	Room unit QAA55.....	21
	Planning.....	21
	Mounting method.....	21
	Connections.....	21
	Dimensions and drilling plan.....	21
3.7	Room unit QAA75.....	22
	Planning.....	22
	Mounting method.....	22
	Connections.....	22
	Dimensions and drilling plan.....	23
3.8	Wireless components.....	24
3.8.1	Radio module AVS71.390.....	24
	Planning.....	24
	Mounting method.....	24

	Connection.....	24
	Radio connection .....	24
	Dimensions and drilling plan .....	24
3.8.2	Room unit QAA78.610 .....	25
	Planning .....	25
	Mounting with base .....	25
	Connection / power supply.....	26
	Radio connection .....	26
	Dimensions and drilling plan .....	27
3.8.3	Wireless outside sensor AVS13.399.....	28
	Mounting method .....	28
	Radio connection .....	29
	Dimensions and drilling plan .....	29
3.8.4	Radio repeater AVS14.390 .....	30
	Mounting method .....	30
	Connections .....	30
	Radio connection .....	30
	Dimensions and drilling plan .....	30
3.8.5	Checking the wireless components .....	31
4	Commissioning .....	31
4.1	Basic units.....	31
5	Handling.....	32
5.1	QAA75.. / QAA78... / AVS37.....	32
5.1.1	Operation .....	32
	Operating elements.....	32
	Display options.....	33
	Selecting heating mode .....	33
	Selection of cooling mode.....	34
	Selecting DHW heating mode.....	34
	Adjusting the room temperature setpoint.....	34
	Occupancy button .....	35
	Displaying information.....	35
5.1.2	Programming .....	37
	Setting principle .....	37
	Example: "Setting the time of day".....	37
5.1.3	User levels .....	38
	Setting the structure "End user" .....	39
	Setting the structure "Heating engineer" .....	39
5.1.4	Overview of settings.....	40
5.2	AVS37.390.....	51
5.2.1	Operation .....	51
	Operating elements.....	51
	Display options.....	51
	Selecting the operating mode .....	51
	Adjusting the room temperature setpoint.....	51
	Adjusting the nominal DHW setpoint .....	51
	Displaying information.....	51
	Setting principle .....	51
	Example: "Setting the time of day"Error! No bookmark name given.....	51

5.2.2	User levels .....	51
5.2.3	Overview of settings .....	51
5.3	QAA55 .....	51
5.3.1	Operation .....	51
	Operating elements .....	51
	Display options .....	51
	Selecting heating mode .....	51
	Display cooling mode .....	51
	Adjusting the room temperature setpoint.....	51
	Occupancy button.....	51
5.3.2	Programming .....	51
6	The settings in detail.....	51
6.1	Time of day and date .....	51
6.2	Operator section .....	51
	Operation and display.....	51
	Heating circuit assignment .....	51
	Room sensor .....	51
	Device data.....	51
6.3	Radio .....	51
	Binding.....	51
	List of wireless devices .....	51
6.4	Time programs .....	51
	Switching points.....	51
	Standard program.....	51
6.5	Holidays .....	51
6.6	Heating circuits .....	51
	Operating mode.....	51
	Setpoints.....	51
	Heating curve .....	51
	ECO functions .....	51
	Flow temperature setpoint limits.....	51
	Room influence.....	51
	Room temp limitation.....	51
	Boost heating.....	51
	Quick setback .....	51
	Optimum start / stop control .....	51
	Raising the reduced setpoint.....	51
	Overtemp prot pump circuit .....	51
	Mixing valve control .....	51
	Floor curing function .....	51
	Excess heat draw .....	51
	Buffer storage tank / primary controller .....	51
	Remote control .....	51
6.7	Cooling circuit .....	51
	Operating mode.....	51
	Setpoints.....	51
	Release .....	51
	Cooling curve.....	51
	ECO.....	51
	Summer compensation.....	51

	Flow temperature setpoint limits .....	51
	Room influence .....	51
	Room temp limitation .....	51
	Mixing valve control .....	51
	Dewpoint monitoring .....	51
	Buffer storage tank / primary controller.....	51
	Remote control.....	51
6.8	DHW .....	51
	Setpoints .....	51
	Release.....	51
	Priority.....	51
	Legionella function .....	51
	Circulating pump .....	51
6.9	Hx pumps.....	51
	Hx pumps.....	51
6.10	Primary controller / system pump .....	51
	Primary controller / system pump .....	51
6.11	Solar.....	51
	Charging controller (dT).....	51
	Start function .....	51
	Frost protection for the collector .....	51
	Overtemperature protection for the collector .....	51
	Medium's evaporation temperature .....	51
	Yield measurement.....	51
6.12	DHW storage tank.....	51
	Charging control.....	51
	Overtemperature protection .....	51
	Recooling .....	51
	Electric immersion heater .....	51
	Excess heat draw.....	51
	Plant hydraulics.....	51
6.13	Instantaneous DHW heater.....	51
	Mixing valve control .....	51
6.14	Configuration.....	51
	Heating circuits .....	51
	DHW sensor B3 .....	51
	DHW control element Q3 .....	51
	Output relay QX .....	51
	Input sensor BX .....	51
	Input H1 .....	51
	Mixing valve groups basic unit.....	51
	Extension module .....	51
	QX extension module.....	51
	BX extension module .....	51
	H2 extension module .....	51
	Types of sensor/readjustment.....	51
	Building and room model .....	51
	Frost protection for the plant.....	51
	External requirements.....	51
	Air dehumidifier .....	51
	Sensor state.....	51
	Parameter reset .....	51
	Plant diagram.....	51

	Device data.....	51
6.15	LPB system .....	51
	Address / power supply .....	51
	Central functions.....	51
	Clock.....	51
6.16	Faults.....	51
6.17	Maintenance / special mode.....	51
	Maintenance functions.....	51
	Manual operation.....	51
	Simulations .....	51
	Telephone customer service .....	51
6.18	Input / output test.....	51
6.19	State .....	51
	Messages .....	51
6.20	Diagnostics, heat generation .....	51
6.21	Diagnostics, consumers .....	51
6.22	List of displays .....	51
6.22.1	Error code.....	51
6.22.2	Maintenance code .....	51
6.22.3	Special operation code .....	51
7	Plant diagrams.....	51
7.1	Basic diagrams .....	51
7.1.1	Basic diagram RVS46.543 .....	51
7.1.2	Basic diagram RVS46.530 .....	51
7.2	Extra functions in general .....	51
	Solar .....	51
	DHW storage tank (DHW) .....	51
	Heating/cooling circuit .....	51
	Heat converter .....	51
	Extra functions.....	51
7.3	Extra functions with extension module AVS75.390 .....	51
	2. Mixing valve heating circuit.....	51
	Cooling circuit .....	51
	Solar DHW heating.....	51
	Primary controller .....	51
	Primary DHW controller.....	51
	Instantaneous DHW heater .....	51
	Legend mains voltage .....	51
	Legend low-voltage .....	51
8	Technical data .....	51
8.1	Basic units RVS... .....	51
8.2	Extension module AVS75.390.....	51
8.3	Operator unit and room units AVS37... / QAA7x... / QAA55.....	51
8.4	Power supply AVS16.290 .....	51
8.5	Radio module AVS71.390 .....	51
8.6	Wireless outside sensor AVS13.399 .....	51

8.7	Radio repeater AVS14.390 .....	51
8.8	Sensor characteristics.....	51
8.8.1	NTC 1 k.....	51
8.8.2	NTC 10 k.....	51
8.8.3	PT1000 .....	51
9	Revision history.....	51



# 1 Overview

The present User Manual describes the products listed in the following table and covers handling and configuration of the controls for readers ranging from end users to heating engineers.

Type reference (ASN)	Series	Name
RVS46.530	A	Basic unit zone
RVS46.543	B	Basic unit zone
AVS75.390	B	Extension module
AVS37.294	B	Operator unit
AVS37.390	A	Operator unit basic
QAA75.610	B	Room unit, wired
QAA75.611	B	Room unit with backlight, wired
QAA78.610	B	Room unit, wireless
QAA55.110	B	Room unit basic
AVS16.290	A	Power section
AVS71.390	A	Radio module
AVS14.390	A	Radio repeater
AVS13.399	A	Wireless outside sensor

The following products are described in separate pieces of documentation:

QAC34	Outside sensor NTC 1 k $\Omega$
QAD36	Strap-on temperature sensor NTC 10 k $\Omega$
QAZ36	Immersion temperature sensor NTC 10 k $\Omega$

# 1.1 Product range overview

## 1.1.1 Topology

### Wired

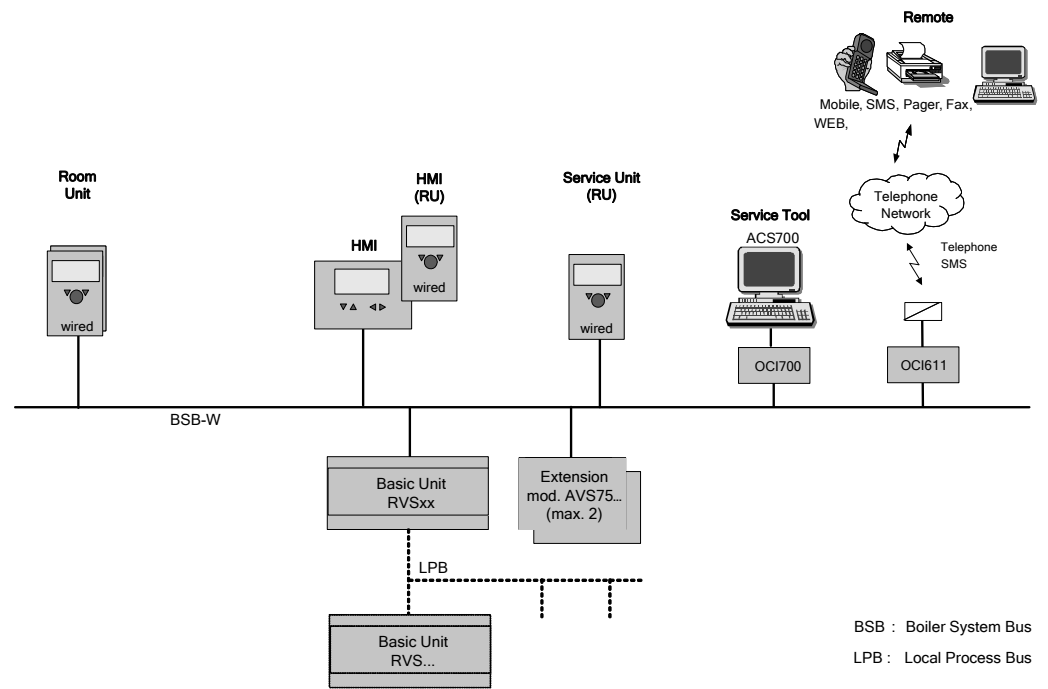

### Wireless

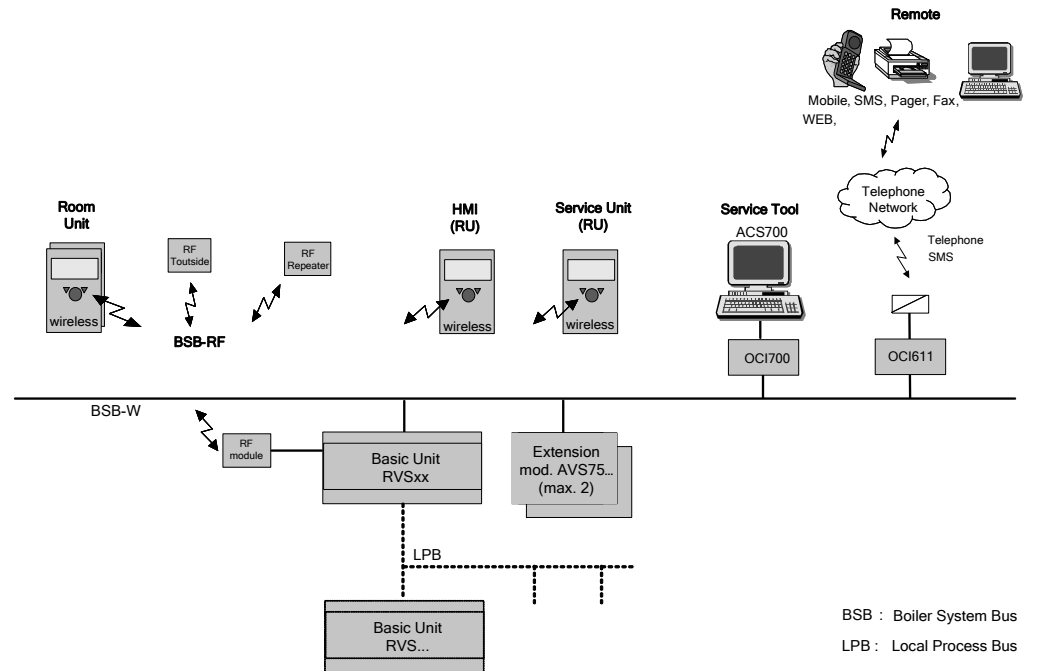

## 1.1.2 Operating options

Operation with room unit

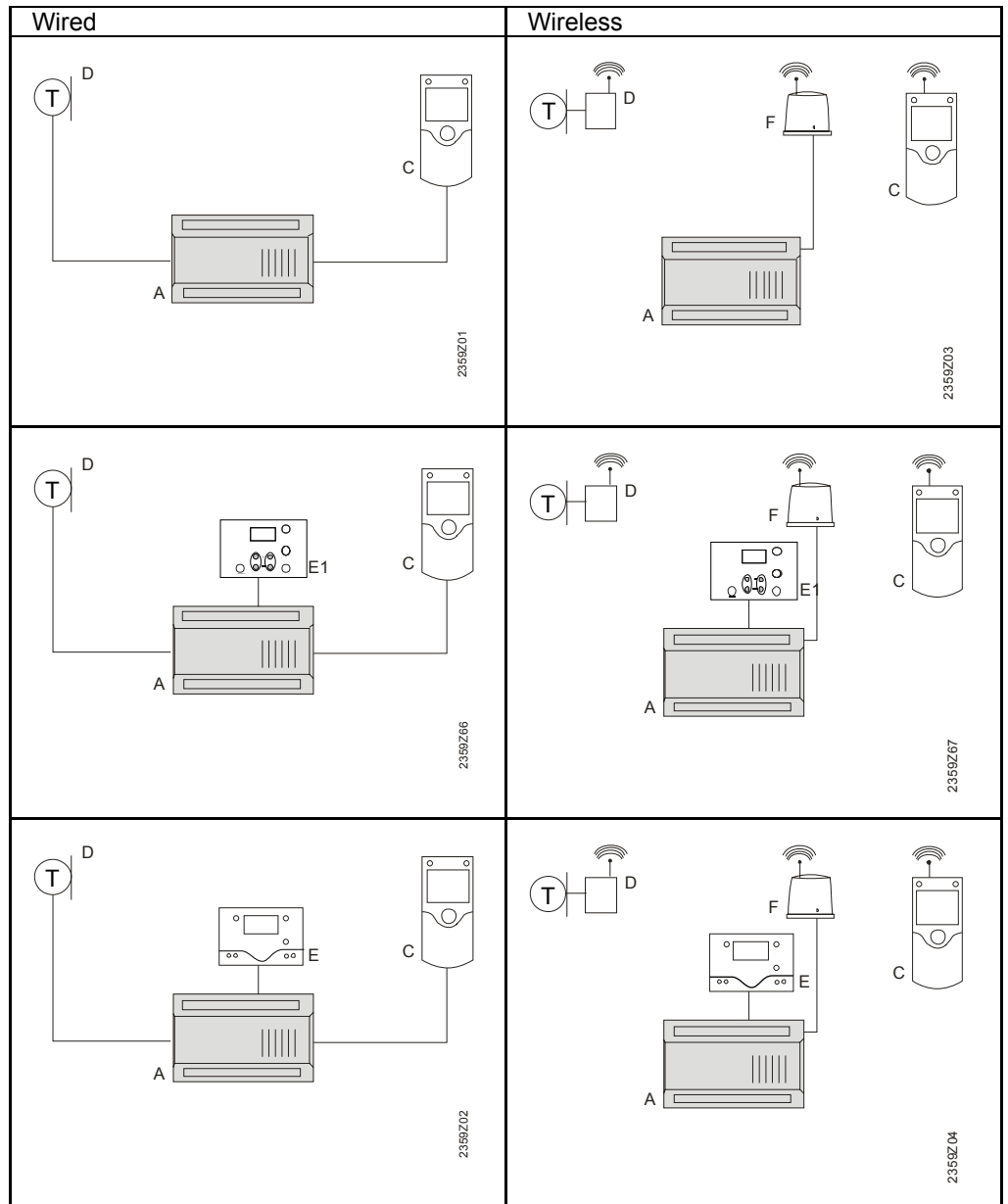

- A Basic unit RVS...
- C Room unit QAA75... / 78... / QAA55..
- D Outside sensor AVS13...
- E Operator unit AVS37.294 (clear-text)
- E1 Operator unit AVS37.390 (basic)
- F Radio module AVS71...

## 2 Safety notes

### 2.1 Product liability

---

- The products may only be used in building services plant and applications as described in this document
- When using the products, all requirements specified in the chapters on "Handling" and "Technical data" must be satisfied
- The local regulations (for installation, etc.) must be complied with
- Do not open the units. If not observed, warranty becomes void.

# 3 Mounting and installation

## 3.1 Regulations

---

### Electrical installation

- Prior to installing the units, power must be turned off
- The connections for mains and low-voltage are separated
- The wiring must be made in compliance with the requirements of safety class II. This means that sensor and mains cables must not be run in the same duct

## 3.2 Basic units RVS...

---

### Planning

- Air circulation around the controller must be ensured, allowing the unit to emit the heat produced by it.  
A clearance of at least 10 mm must be provided for the unit's cooling slots at the top and bottom of the housing.  
That space should not be accessible and no objects should be placed there. If the controller is enclosed in another (insulating) casing, a clearance of up to 100 mm must be observed around the cooling slots
- The controller is designed conforming to the directives for safety class II devices mounted in compliance with these regulations
- Power to the controller may only be supplied when completely fitted. If this is not observed, there is a risk of electric shock hazard near the terminals and through the cooling slots
- The controller must not be exposed to dripping water.
- Permissible ambient temperature when mounted and when ready to operate: 0...50°C.
- Power cables must be clearly segregated from low-voltage cables (sensors) observing a distance of at least 100 mm

### Mounting location

- Boiler
- Control panel
- Housing for wall mounting

## Mounting method

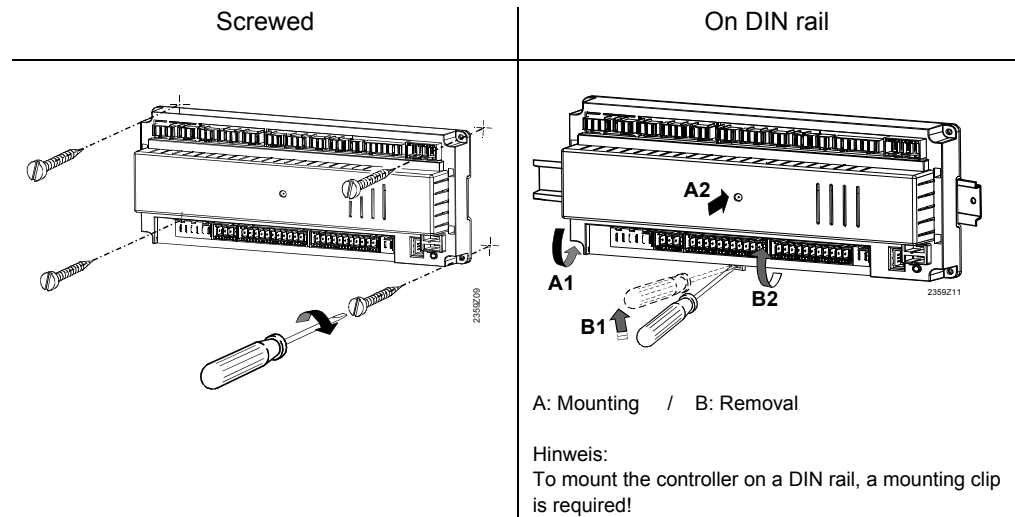

## Dimensions and drilling plan

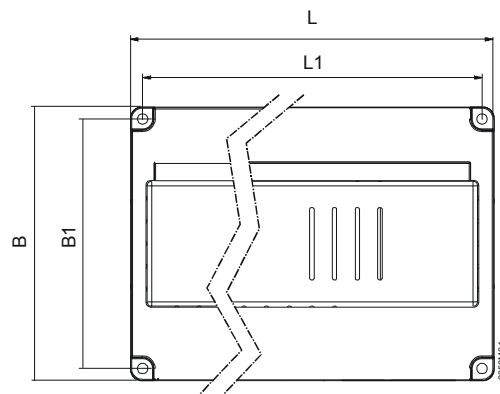

Dimensions in mm

	<i>L</i>	<i>B</i>	<i>H</i>	<i>L1</i>	<i>B1</i>
<b>RVS46.543</b>	181	121	52	170	110
<b>RVS46.530</b>	109	121	52	98	110

## Total height required

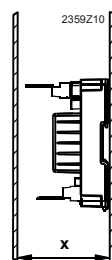

### Masse X:

Connectors with tongues minimum 70 mm

Connector without tongues minimum 60 mm

### 3.2.1 RVS46.530 connection terminals

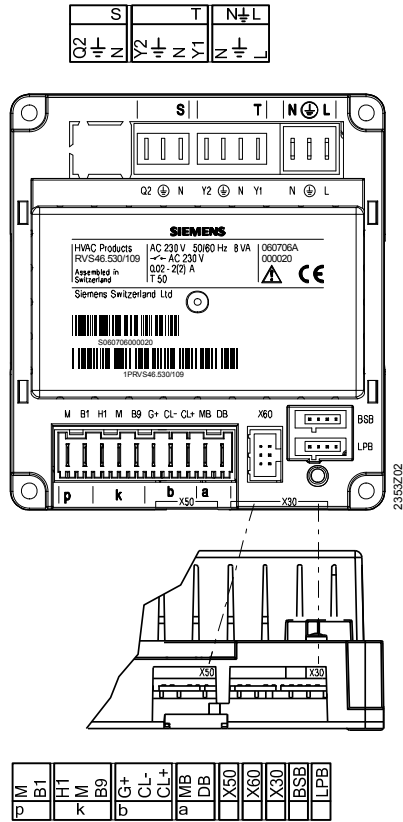

### 3.2.2 RVS46.543 connection terminals

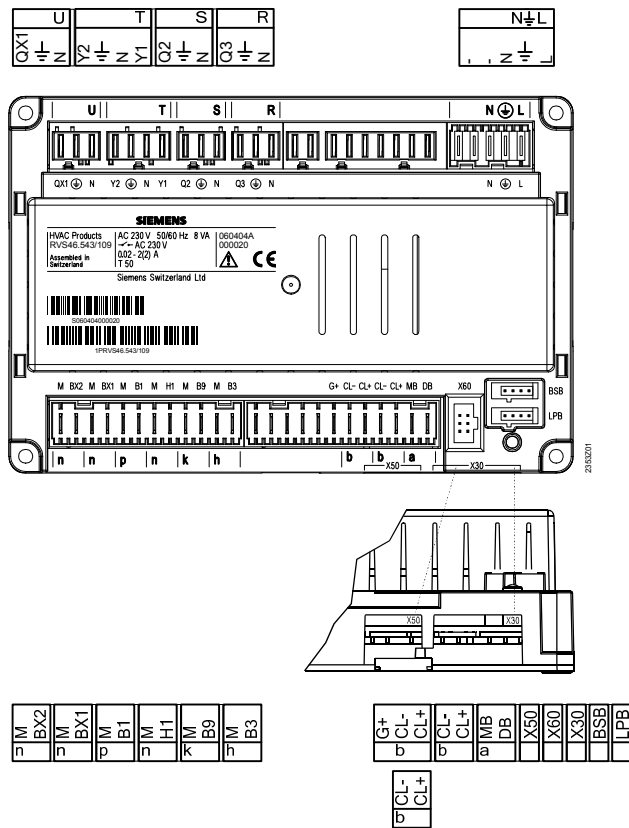

## Terminal markings

### Mains voltage

	<i>Use</i>	<i>Space</i>	<i>Connector type</i>
L	Live AC 230 V basic unit	N $\perp$ L	AGP4S.03E/109 <sup>3)</sup>
$\perp$	Protective earth		AGP4S.05A/109 <sup>4)</sup>
N	Neutral conductor		
N	Neutral conductor	R	AGP8S.03A/109
$\perp$	Protective earth		
Q3	DHW charging pump / diverting valve		
N	Neutral conductor	S	AGP8S.03B/109
$\perp$	Protective earth		
Q2	1. heating circuit pump		
Y1	1st heating circuit mixing valve opening	T	AGP8S.04B/109
N	Neutral conductor		
$\perp$	Protective earth		
Y2	1st heating circuit mixing valve closing		
N	Neutral conductor	U	AGP8S.03C/109
$\perp$	Protective earth		
QX1	1. Multifunctional output		

### Low voltage

	<i>Use</i>	<i>Space</i>	<i>Connector type</i>
BSB	Service tool OCI700	-	-
LPB	Local process bus	-	-
system			
X60	Radio module AVS71.390	-	-
X50	Extension module AVS75.390	-	AVS82.490/109
X30	Operator unit / control panel	-	AVS82.491/109
DB	LPB data	a	AGP4S.02H/109
MB	LPB ground		
CL+	BSB data		AGP4S.02A/109
CL-	BSB ground	b	
CL+	Room unit 1 data		AGP4S.02A/109
CL-	Room unit 1 ground	b	AGP4S.03D/109
G+	Room unit power supply 12 V		
B3	DHW sensor top		AGP4S.02C/109
M	Ground	h	
B9	Outside sensor		AGP4S.03F/109 <sup>3)</sup>
M	Ground	k	AGP4S.02D/109 <sup>4)</sup>
H1	Digital / DC 0...10 V input		AGP4S.02F/109
M	Ground	n	
B1	Flow sensor heating circuit 1		AGP4S.02G/109
M	Ground	p	
BX1	Multifunctional sensor input 1		AGP4S.02F/109
M	Ground	n	
BX2	Multifunctional sensor input 2		AGP4S.02F/109
M	Ground	n	

<sup>3)</sup> RVS46.530

<sup>4)</sup> RVS46.543



### 3.3 Extension module AVS75.390



For planning, mounting location and mounting method, refer to the information given for the basic modules.

#### Dimensions and drilling plan

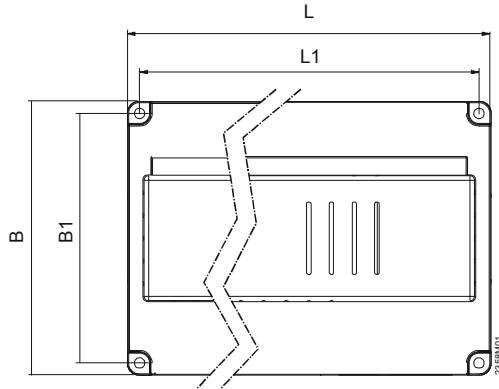

Dimensions in mm

	L	B	H	L1	B1
<b>AVS75.390</b>	109	121	52	98	110

#### Connections

The AVS75.390 extension module is connected to terminal X50 of the basic unit using the AVS83.490/109 connecting cable. The connectors are coded.

#### 3.3.1 AVS75.390 connection terminals

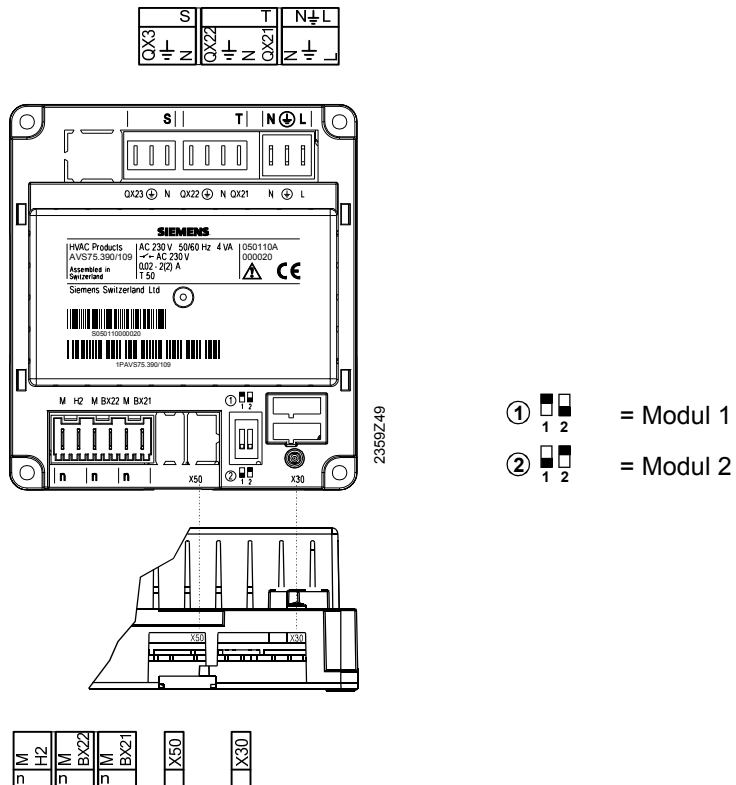

## Terminal markings

### Mains voltage

	<i>Use</i>	<i>Space</i>	<i>Connector type</i>
L	Live AC 230 V basic unit	N $\perp$ L	AGP4S.03E/109
$\perp$	Protective earth		
N	Neutral conductor		
QX21	Assignment according to function	T	AGP8S.04B/109
N	Neutral conductor		
$\perp$	Protective earth		
QX22	Assignment according to function		
N	Neutral conductor	S	AGP8S.03B/109
$\perp$	Protective earth		
QX23	Assignment according to function		

### Low voltage

	<i>Use</i>	<i>Space</i>	<i>Connector type</i>
X30	Operator unit / control panel	-	AVS82.491/109
X50	Basic unit		AVS82.490/109
BX21	Assignment according to function	n	AGP4S.02F/109
M	Ground		
BX22	Assignment according to function	n	AGP4S.02F/109
M	Ground		
H2	Digital / DC 0...10 V input	n	AGP4S.02F/109
M	Ground		

## Assignment of terminals

The two parameters

- Function extension module 1 (operating line 6020)
  - Function extension module 2 (operating mode 6021)
- define the usage of the respective module.

### 3.4 Operator unit AVS37.294

#### Mounting method

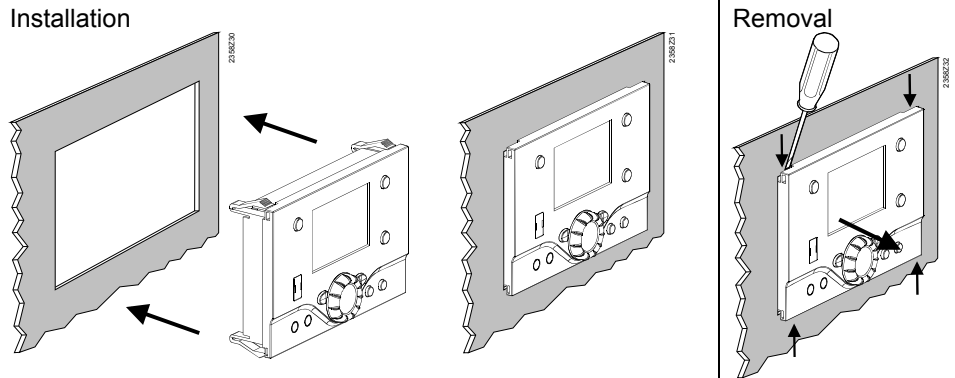

#### Connections

The AVS37.294 operator unit must be connected to terminal X30 of the basic unit using the AVS82.491/109 connecting cable. The connectors are coded.

#### Ground

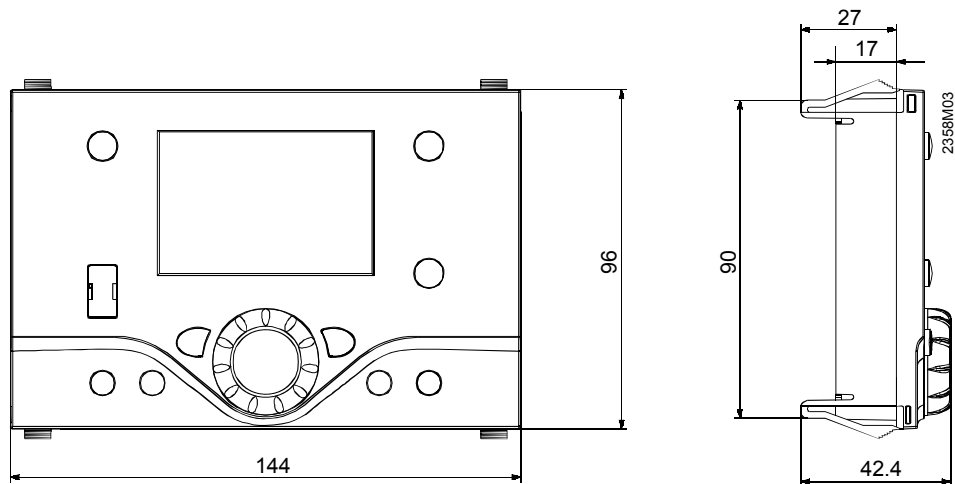

#### Panel cutout

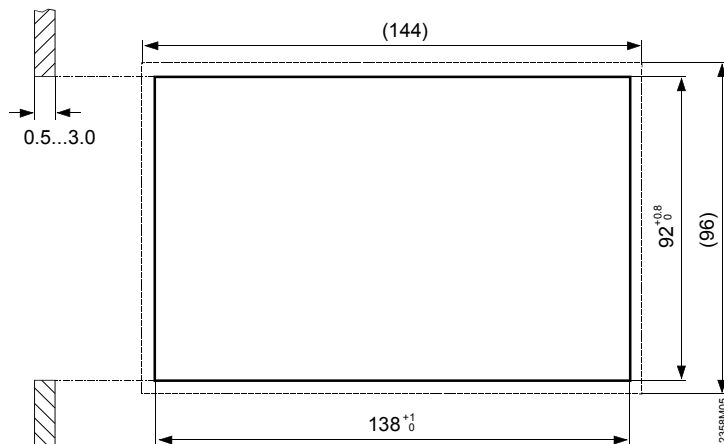

## 3.5 Operator unit AVS37.390

### Connections

The AVS37.390 operator unit must be connected to terminal X30 of the basic unit using the AVS82.491/109 connecting cable. The connectors are coded.

### Dimensions

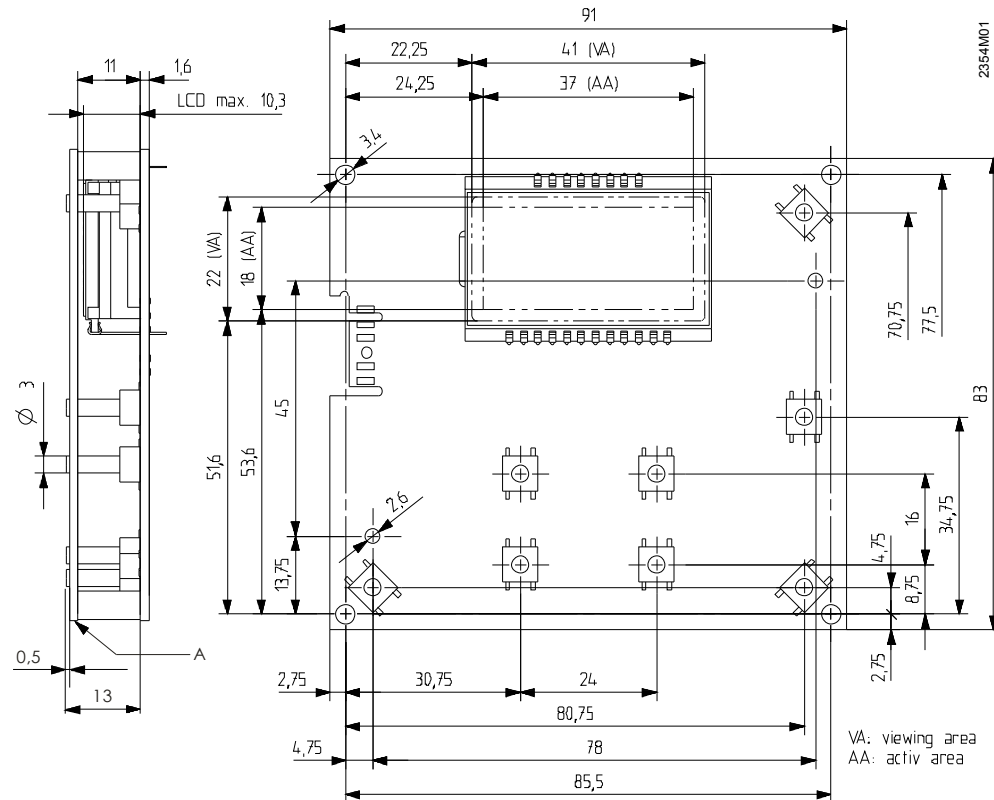

A Control panel, front

## 3.6 Room unit QAA55...

### Planning

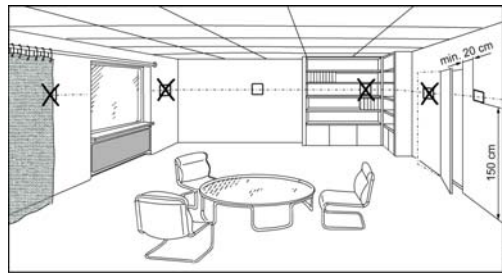

The room unit should be located in the main living room while giving consideration to the following points:

- The place of installation should be chosen so that the sensor can capture the room temperature as accurately as possible without getting adversely affected by direct solar radiation or other heat or refrigeration sources (about 1.5 meters above the floor)
- In the case of wall mounting, there must be sufficient clearance above the unit, enabling it to be fitted and removed



When the unit is removed from its base, power is cut off so that the unit is out of operation.

### Mounting method

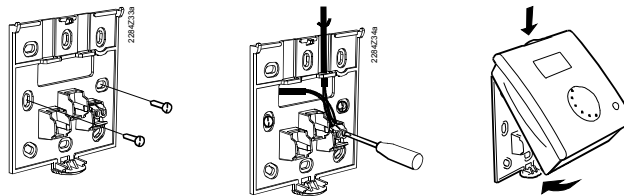

- The controller must not be exposed to dripping water

### Connections

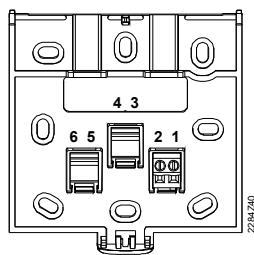

CL+  
CL-

BSB data  
BSB ground

### Dimensions and drilling plan

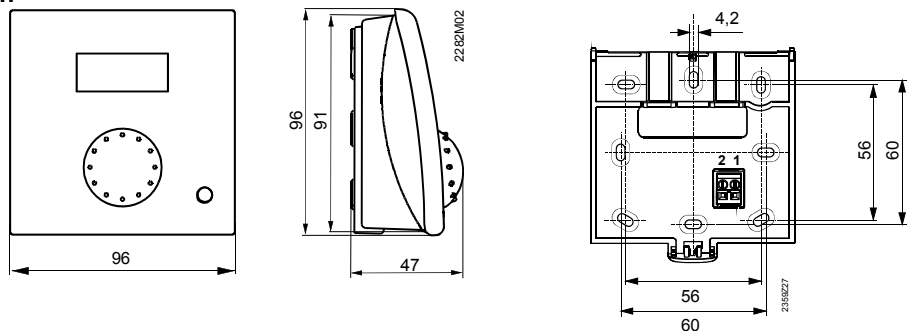

## 3.7 Room unit QAA75...

### Planning

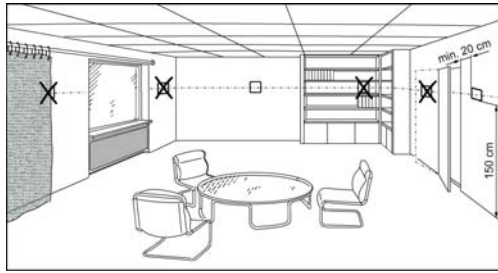

The room unit should be located in the main living room while giving consideration to the following points:

- The place of installation should be chosen so that the sensor can capture the room temperature as accurately as possible without getting adversely affected by direct solar radiation or other heat or refrigeration sources (about 1.5 meters above the floor)
- In the case of wall mounting, there must be sufficient clearance above the unit, enabling it to be fitted and removed



When the unit is removed from its base, power is cut off so that the unit is out of operation.

### Mounting method

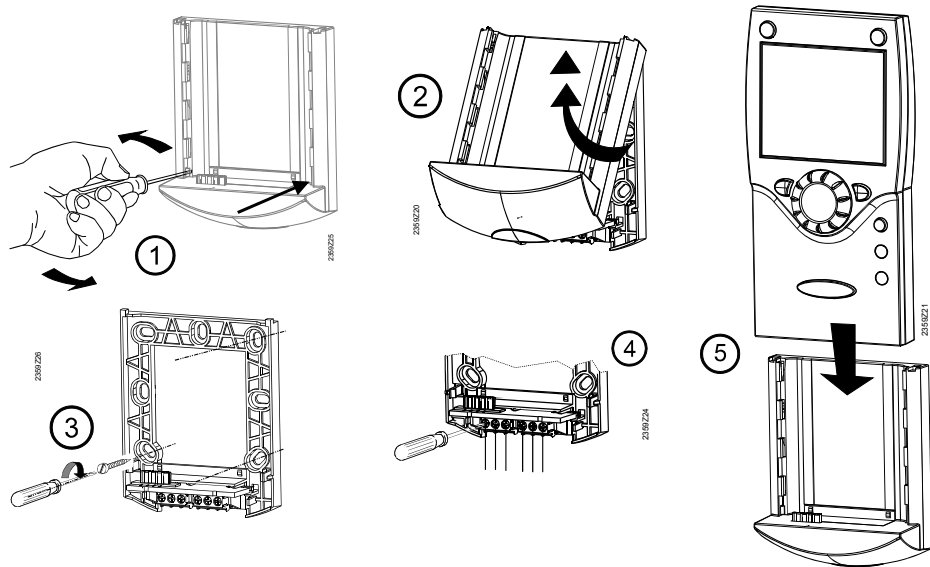

### Connections

Terminal	Designation	QAA75.610	QAA75.611
1	CL+	BSB data	BSB data
2	CL-	BSB ground	BSB ground
3	G+	Reserved	Power supply DC 12 V

## Dimensions and drilling plan

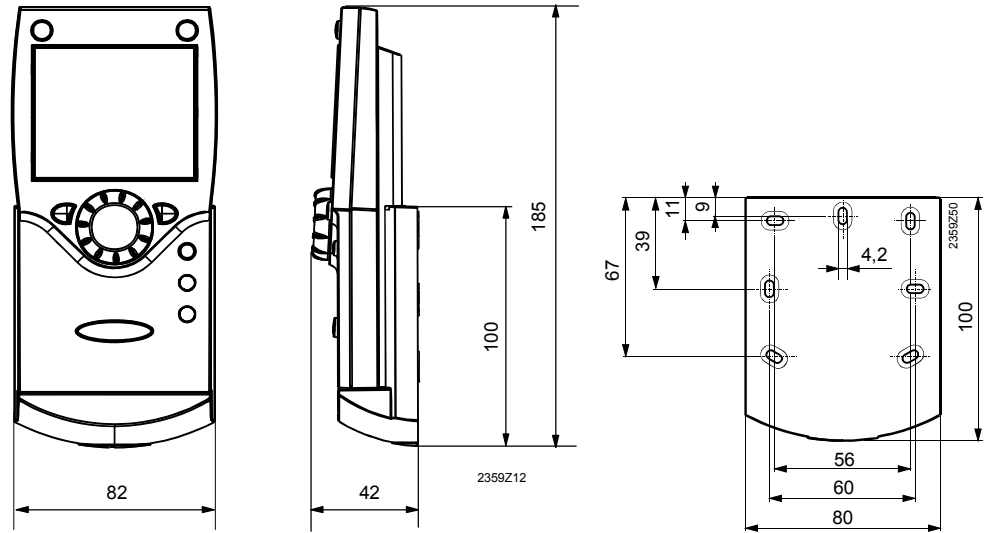

## 3.8 Wireless components

The wireless components should be located such that transmission will be as interference-free as possible. The following criteria must be observed:

- Not in the vicinity of electrical cables, strong magnetic fields or equipment like PCs, TV sets, microwave ovens, etc.
- Not near larger metal structures or constructional elements with fine metal meshes such as special glass or special concrete
- The distance to the transmitter should not exceed 30 meters or 2 floors

### 3.8.1 Radio module AVS71.390

The radio module extends the product range by introducing wireless communication. With this type of device, the system components, such as room units, transmit data with no need for laying cables.

#### Planning

#### Mounting method

Do not install the radio module inside metal casings (e.g. inside a boiler).

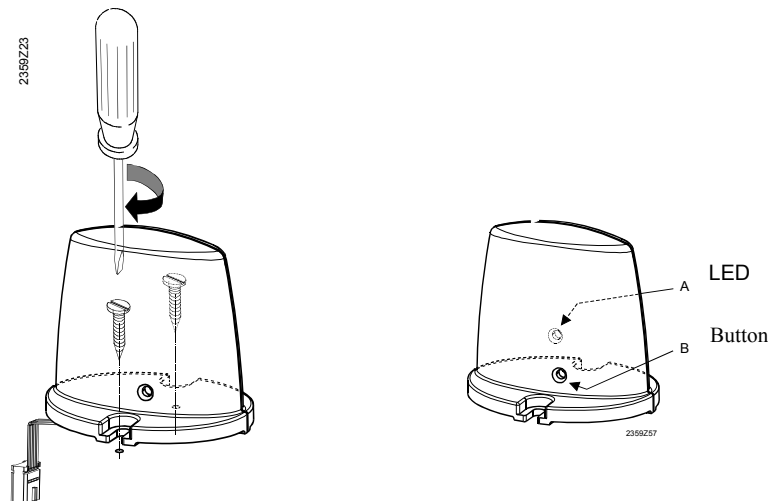

#### Connection



The prefabricated cable is to be connected to terminal X60 of the controller. Prior to connecting, the basic unit must be disconnected from power!

#### Radio connection

Establishment of the wireless connection is described in the following sections which cover the relevant radio-controlled units.

#### Dimensions and drilling plan

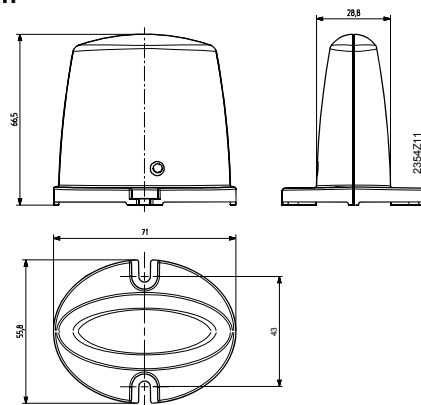



## 3.8.2 Room unit QAA78.610

### Planning

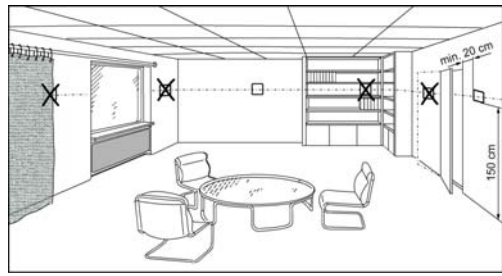

The room unit should be located in the main living room while giving consideration to the following points:

- The place of installation should be chosen so that the sensor can capture the room temperature as accurately as possible without getting adversely affected by direct solar radiation or other heat or refrigeration sources (about 1.5 meters above the floor)
- In the case of wall mounting, there must be sufficient clearance above the unit, enabling it to be fitted and removed

### Mounting with base

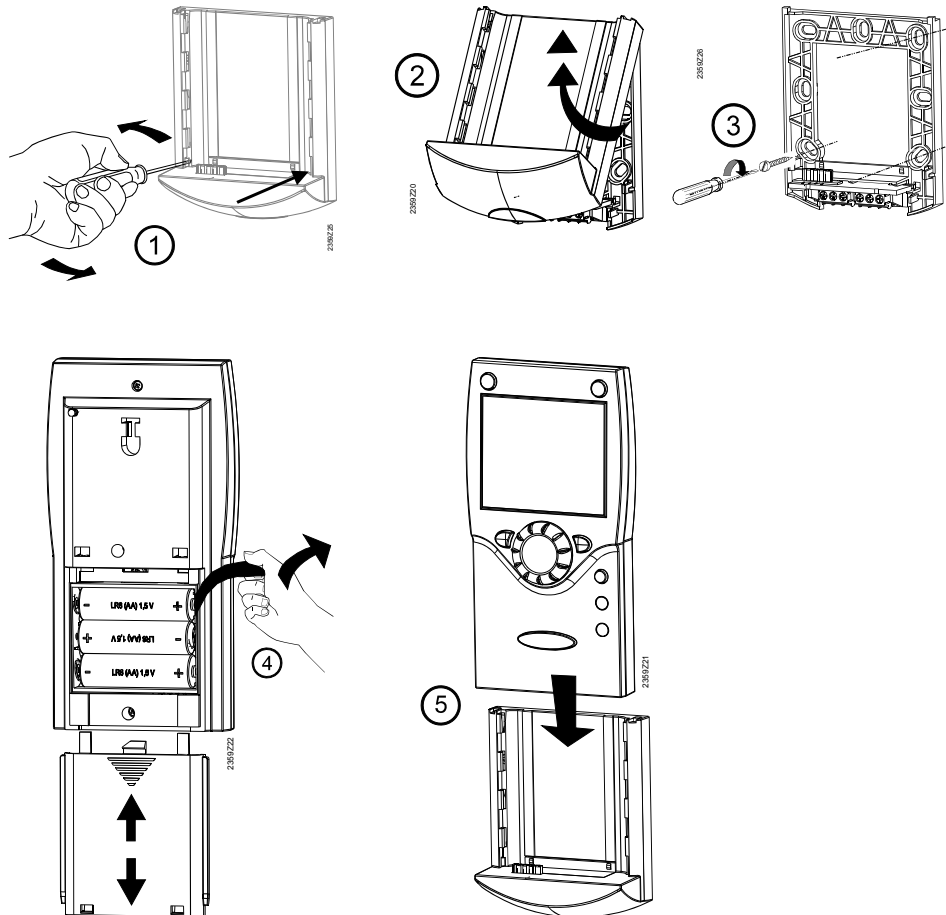

## Mounting without base

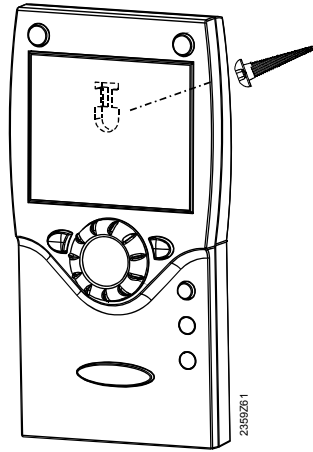

## Connection / power supply

The room unit is powered by 3 pieces 1.5 V alkaline batteries type AA (LR06).

## Radio connection



Make the radio connection in the vicinity of the radio module prior to mounting so that all systems are within easy reach.

Prerequisite for the radio connection is that all components receive power, which means that the radio module must be correctly connected to the basic unit and the batteries must be correctly installed in the room unit.

## Establishing the link

1. Press the button on the installed radio module for at least 8 seconds until the LED on the radio module starts flashing at high frequency.
2. Press OK on the room unit to switch to programming.
3. Press the info button for at least 3 seconds and select operating level "Commissioning" with the setting knob. Then, press OK.
4. Select operating page "Operator unit" and press OK.
5. Select operating line "Used as" (operating line 40) and make the appropriate selection. Then, press OK.
6. Select operating page "Radio" and press OK.
7. Select setting line "Binding" (line 120). Then, press OK.
8. Set the setting knob to "YES" and press OK. Connection establishment is started.
9. The display shows the progress of connection establishment in %. This process can take 2 to 120 seconds.
10. The connection is established when "Device ready" appears and the LED on the radio module extinguishes

## Testing



The test is made to check the quality of the radio link.

- The test can be aborted by pressing the ESC button.
- While the radio link can be opened on the controller, the test should be made at the location where the room unit will be installed

On the room unit, as described above (points 2 through 4), select operating page "Radio" and activate the test mode on setting line "Test mode" (line 121).

Example of a display during the test:

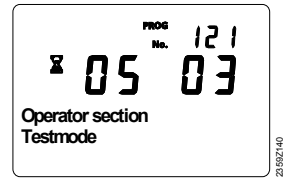

The digits on the left show telegrams that have been sent, the digits on the right telegrams that have been received. The test will be ended after 24 telegrams. The test is considered successful when at least 50 % of the telegrams sent have been received.

If the test was not successful, some other mounting location is to be selected or the AVS14.390 radio repeater can be used.

### Dimensions and drilling plan

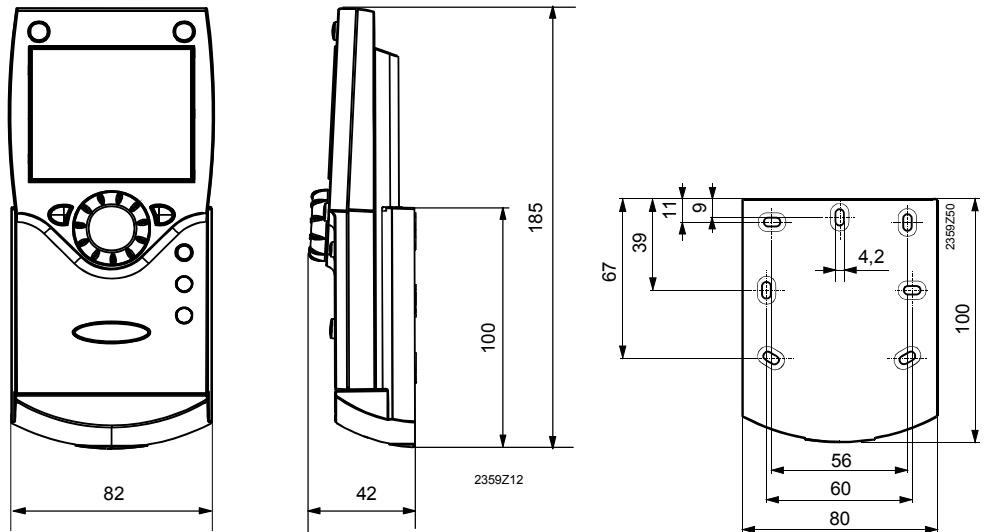

### 3.8.3 Wireless outside sensor AVS13.399



- The radio transmitter must be installed inside the building.
- The radio transmitter's mounting location should be chosen such that batteries can be easily changed.

#### Mounting method

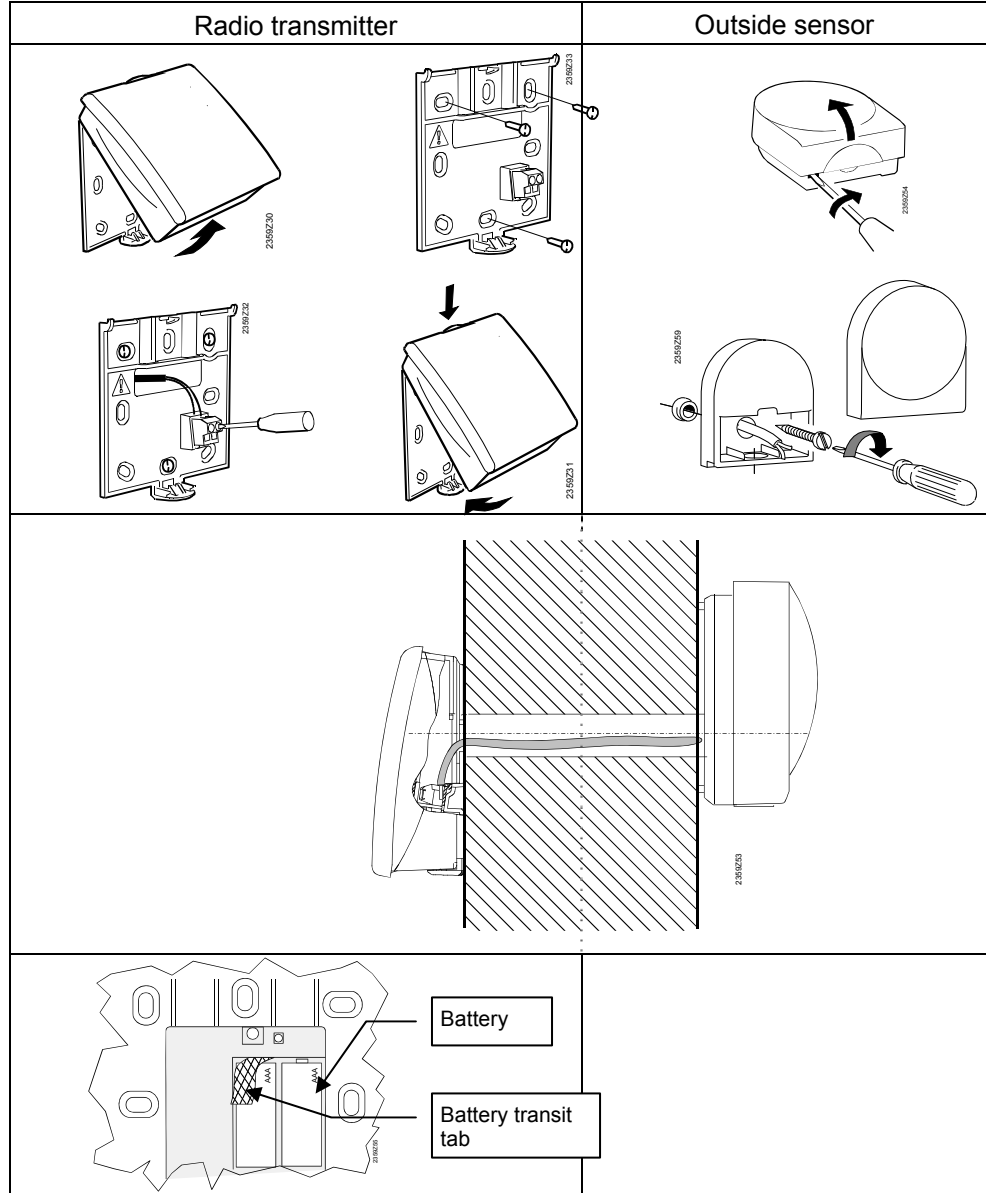

#### Connections

The outside sensor is to be connected to the radio transmitter via a 2-core cable, the connections are interchangeable.

The room unit is powered by 2 pieces 1.5 V alkaline batteries type AAA (LR03).

## Radio connection



Make the radio connection in the vicinity of the radio module prior to mounting so that all systems are within easy reach.

Prerequisite for the radio connection is that all components receive power, which means that the radio module must be correctly connected to the basic unit and the batteries must be correctly installed in the room unit.

### Establishing the link

1. Press the button on the radio module for at least 8 seconds until the LED on the radio module starts flashing at **high frequency**.
2. Press the button on the transmitter of the wireless outside sensor for at least 8 seconds until that LED also starts flashing at **high frequency**.
3. The connection is established when the LED on the radio module extinguishes.
4. Press the button on the transmitter of the wireless outside sensor briefly again until the LED extinguishes.

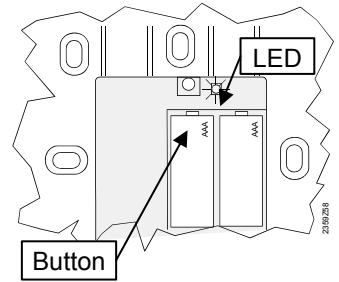

### Testing



The test is made to check the quality of the radio link.

- The test can be aborted by pressing the ESC button.
  - While the radio link can be opened on the controller, the test should be made at the location where the room unit will be installed
5. Press button 3 on the transmitter of the wireless outside sensor for a maximum of 8 seconds until the LED start flashing at **low frequency**.
  6. When radio communication works, the LED on the radio module flashes briefly at 10-second intervals.
  7. After the test, press the button on the transmitter of the wireless outside sensor again briefly until the LED extinguishes.

## Dimensions and drilling plan

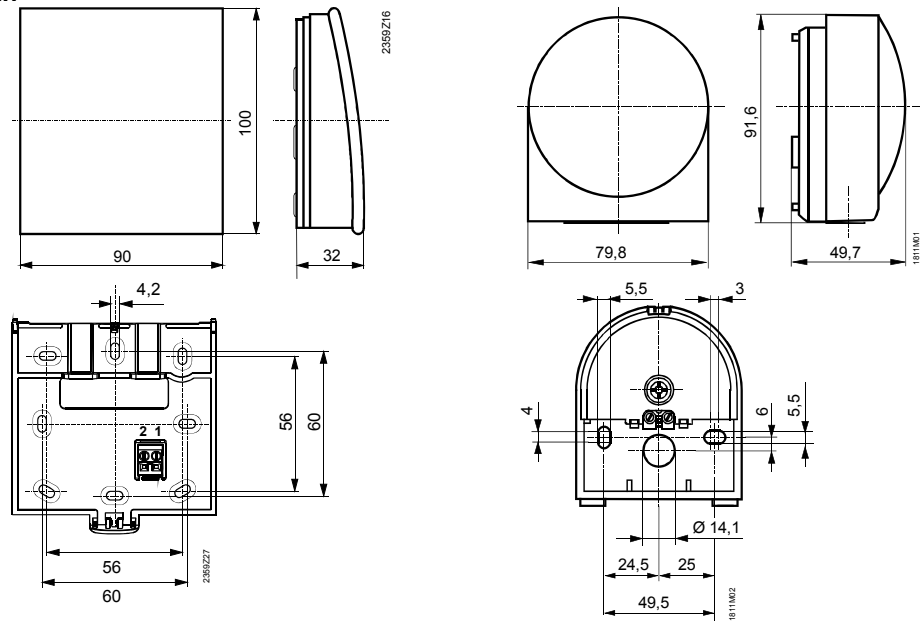

### 3.8.4 Radio repeater AVS14.390



- To establish the radio connection, the device must be provisionally connected to power prior to mounting, enabling the radio connection to be opened and tested.
- The radio repeater must be fitted inside the building.

#### Mounting method

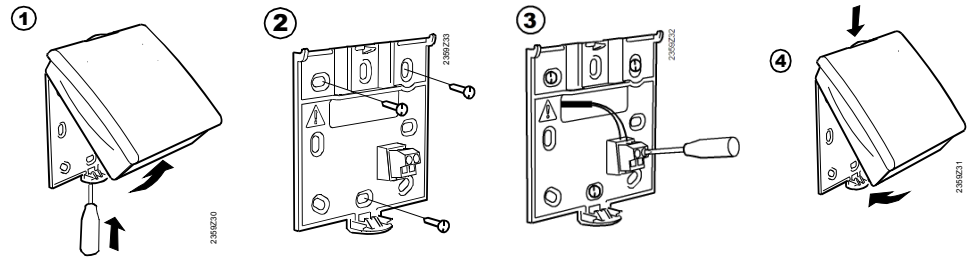

#### Connections

Power is supplied via the enclosed power pack. The wires are interchangeable.

#### Radio connection



Make the radio connection in the vicinity of the radio module prior to mounting so that all systems are within easy reach.

Prerequisite for the radio connection is that all components receive power, which means that the radio module must be correctly connected to the basic unit and power must be correctly supplied to the radio repeater.

#### Establishing the link

8. Press the button on the radio module for at least 8 seconds until the LED on the radio module starts flashing at **high frequency**.
9. Press the button on the installed radio repeater until the LED start flashing at **high frequency**.
10. The connection is established when the LED on the radio module extinguishes.

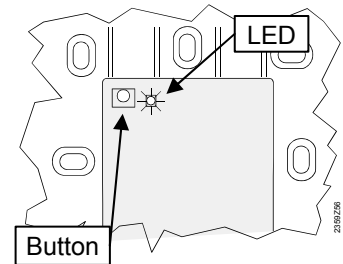

#### Testing



The test is made to check the quality of the radio link.

- The test can be aborted by pressing the ESC button.
  - While the radio link can be opened on the controller, the test should be made at the location where the room unit will be installed
11. Press button 3 on the radio repeater for a maximum of 8 seconds until the LED starts flashing at **low frequency**.
  12. When radio communication works, the LED on the radio module flashes briefly at 10-second intervals.
  13. After the test, press the button on the radio repeater again briefly until the LED extinguishes.

#### Dimensions and drilling plan

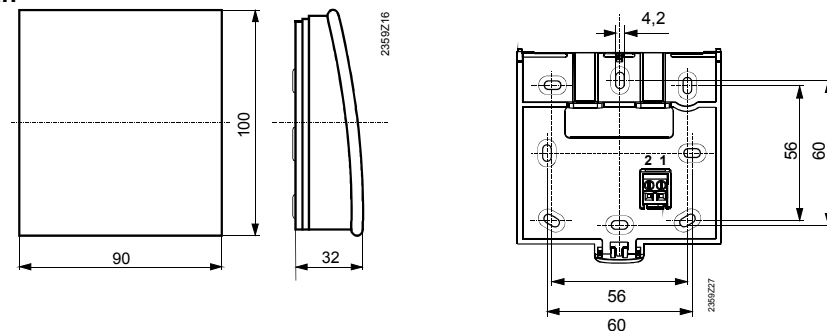

### 3.8.5 Checking the wireless components

To check whether the connections to the required system components are operational, consult operating lines 130 through 135 on operating page "Wireless" (operating level "Commissioning").

## 4 Commissioning

### Prerequisites

To commission the units, the following working steps must be carried out:

- Prerequisite is the correct mounting and correct electrical installation and, in the case of wireless solutions, correctly working radio connections to all required auxiliary units.
- Make all plant-specific settings. Special attention must be paid to operating page "Configuration". For that purpose, the relevant operating level is to be selected as follows:  
Press OK on the room unit to switch to programming.  
Press the info button for at least 3 seconds and select operating level "Commissioning" with the setting knob. Then, press OK.
- Make the functional check as described below.
- Reset the attenuated outside temperature (operating page "Diagnostics of consumers", operating line "Outside temp attenuated" (operating line 8703))

### Functional check

To facilitate commissioning and fault tracing, the controller allows output and input tests to be made. With these tests, the controller's inputs and outputs can be checked. To make the tests, switch to operating page "Input / output test" and go through all available setting lines.

### Operating state

The current operating state can be checked on operating page "State".

### Diagnosis

For detailed diagnostics of the plant, check operating pages "Diagnostics heat source" and "Diagnostics consumer".

## 4.1 Basic units

### Checking the LED

LED off:	No power supply
LED on	Ready
LED flashes	Local fault

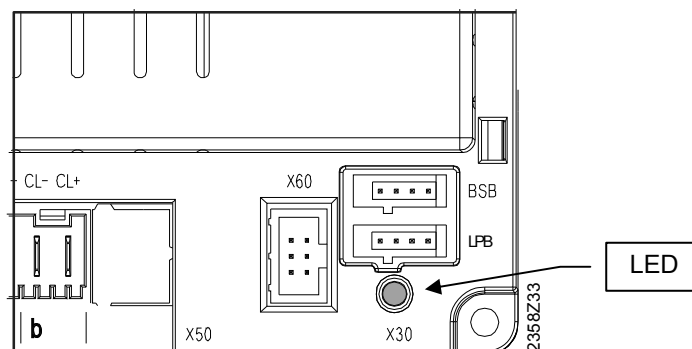

# 5 Handling

## 5.1 QAA75.. / QAA78... / AVS37..

### 5.1.1 Operation

Operating elements  
Room unit

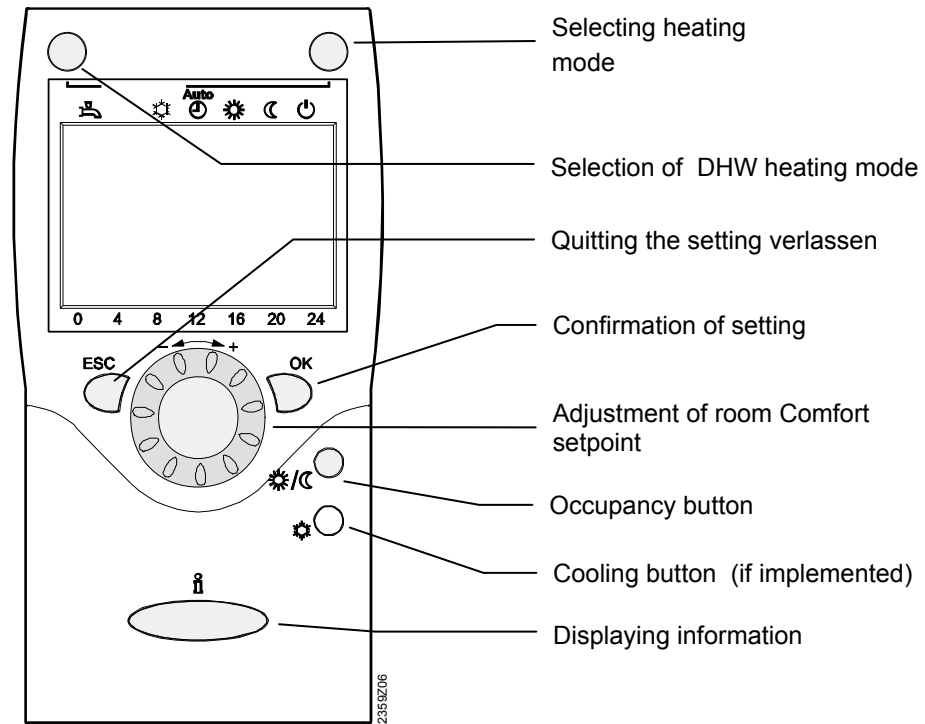



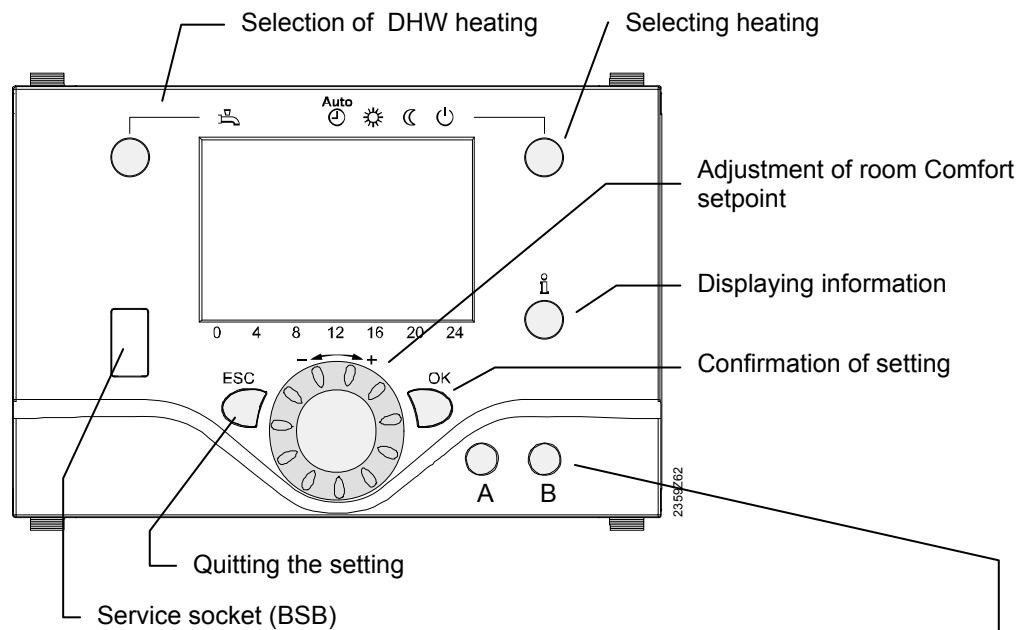







Operator unit



	A	B
AVS37.294/109	Manual operation	No function
AVS37.394/109		
AVS37.294/509		
AVS37.294/209	No button	No button
AVS37.294/309	Cooling button	No function, Reset



## Display options

	Heating to Comfort setpoint	<b>INFO</b>	Info level activated
	Heating to Reduced setpoint	<b>PROG</b>	Programming activated
	Heating to frost protection setpoint	<b>ECO</b>	Heating temporarily switched off ECO function active
	Process running – please wait		Holiday function active
	Change battery		Reference to heating circuit
	Burner operating (only oil / gas boiler)		Maintenance / special operation
			Error messages

## Display

Display of all symbols and segments.

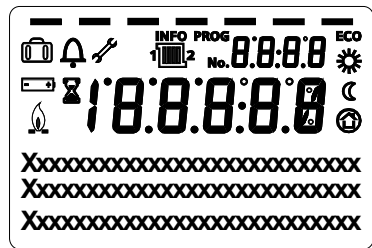



## Selecting heating mode

This setting is used to switch between the different operating modes. The selection made is indicated by a bar which appears below the respective symbol.





### Automatic mode

Automatic mode controls the room temperature according to the time program. Characteristics of automatic mode:

- Heating mode according to the time program
- Temperature setpoints according to the heating program "Comfort setpoint"  or "Reduced setpoint" 
- Protective functions active
- Automatic summer / winter changeover (ECO functions)

### Continuous operation or

Continuous operation maintains the room temperature at the selected operating level.

-  Heating to Comfort setpoint
-  Heating to Reduced setpoint

Characteristics of continuous operation:

- Heating mode with no time program
- Protective functions active
- Automatic summer / winter changeover (ECO functions) and 24-hour heating limit inactive in the case of continuous operation with Comfort setpoint

## Protection mode

When using Protection, the heating system is off. However, it remains protected against frost (frost protection temperature) provided there is no power failure.

Characteristics of Protection:

- Heating off
- Temperature according to frost protection
- Protective functions active
- Automatic summer / winter changeover (ECO functions) and automatic 24-hour heating limit active

## Selection of cooling mode

(if available)

### Cooling mode

The "Cooling" mode is selected by use of the Cooling button. The choice made is indicated by a bar which appears below the symbol. Cooling mode controls the room temperature in accordance with the time program.

Characteristics of cooling mode:

- Cooling mode based on time program
- Temperature setpoint based on "Comfort setpoint, cooling"
- Protective functions active
- Kühlgrenze nach Aussentemperatur



## Selecting DHW heating mode

The button is used to switch DHW heating mode on and off. The selection made is indicated by a bar which appears below the respective symbol.

### DHW mode

- On

The DHW is treated according to the selected switching program.

- Off

No DHW heating, the protective function is active.

### DHW push

Triggering is effected by keeping the DHW operating mode button on the operator or room unit depressed for at least 3 seconds.

It can also be started when:

- The operating mode is "Off"
- Operating mode changeover acts via H1 or centrally (LPB)
- All heating circuits use the holiday function

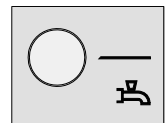



## Adjusting the room temperature setpoint

Either the heating or the cooling setpoint is set depending on the active operating state.

Turn the setting knob to increase or decrease the

**Comfort setpoint** .

The programming allows for setting the reduced setpoint  and the frost protection setpoint .

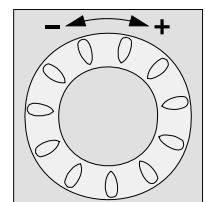

After each readjustment, wait at least 2 hours, allowing the room temperature to adapt.

## Occupancy button

If you do not use the rooms for a longer period of time, you can press the occupancy button to temporarily reduce heating / cooling. When the rooms are occupied again, press again the occupancy button.

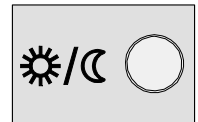

**Heating mode:**  
 Heating to Comfort setpoint  
 Heating to Reduced setpoint

**Cooling mode:**  
 Cooling to Comfort setpoint  
 Cooling OFF (no symbol)



- The occupancy button is only active in automatic operation
- The current selection is active until the next switching action according to the timeswitch program takes place

## Displaying information

Various data can be displayed by pressing the info button.

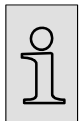
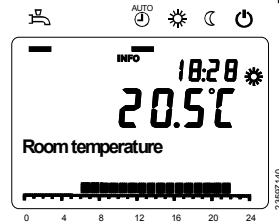

## Possible displays

Depending on the type of unit, configuration and operating state, some of the info lines listed below may not appear.

Display:

- Possible error messages from the error code list on page 51
- Possible service messages from the maintenance code list on page 51
- Possible special mode messages from page 51

Other displays:

- |                            |                              |
|----------------------------|------------------------------|
| – Room temperature         | – State of heating circuit 1 |
| – Room temperature minimum | – State of heating circuit 2 |
| – Room temperature maximum | – State heating circuit P    |
| – Outside temperature (OT) | – State of DHW               |
| – Outside temp min         | – State of solar             |
| – Outside temp max         | – Date and time of day       |
| – DHW temp 1               | – Telephone customer service |

## Exception

In exceptional cases, the basic display shows one of the following symbols:



**Error messages**

If this symbol appears, an error in the plant has occurred. Press the info button and read further information.

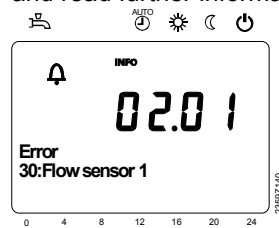

**Maintenance or special operation**

If this symbol appears, a maintenance alarm is delivered or the plant has changed to special mode. Press the info button and read further information.

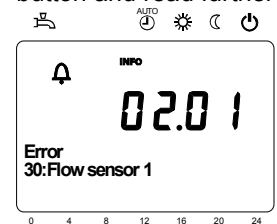

A list of possible displays is given on page 51.

## Reset function

The reset function for meters and the resettable parameters appears on the bottom line of the display, provided a reset is permitted on the current operating line (end user / commissioning / heating engineer).

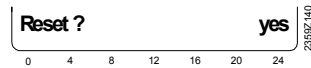

After activation with the OK button, the display will show a flashing "Yes".

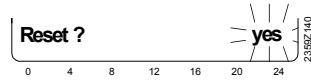

After confirmation with the OK button, the relevant parameter or counter will be reset.

## Manual operation

When manual operation is active, the relays are no longer energized and deenergized according to the control state, but are set to a predefined manual operation state depending on their function.

The burner relay energized in manual control can be deenergized by the electronic temperature controller (TR).

Setpoint adjustment in manual control

After manual control has been activated, a change to the basic display must be made.

There, the maintenance / special mode symbol  appears.

Press the info button to switch to info display "Manual mode", where the setpoint can be adjusted.

## Chimney sweep function

The chimney sweep function is activated by a short press (maximum 3 seconds) on the chimney sweep button. This function produces the operating state required to make emission measurements (flue gas).

SLT test

The SLT test (SLT = safety limit thermostat) is activated by a long press (longer than 3 seconds) on the chimney sweep button. The button must be kept depressed during the entire test. If released, the test will be aborted. The SLT test is shown on the display.

The test may only be made by qualified staff since the boiler temperature will be raised above the maximum limits.



## 5.1.2 Programming

### Setting principle



Settings that cannot be made directly with the operating elements require programming. For this purpose, the individual settings are structured in the form of operating pages and operating lines, thus forming practical groups of settings. The following example shows how to set the time of day and the date.

#### Example: “Setting the time of day“

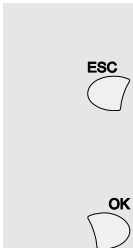
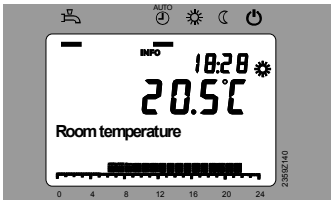
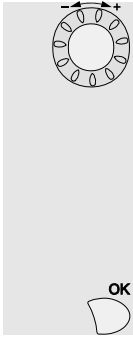
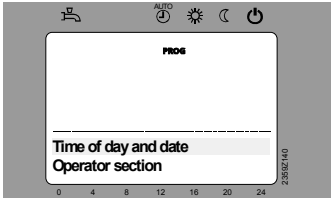
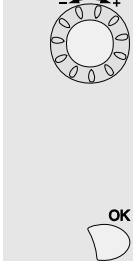
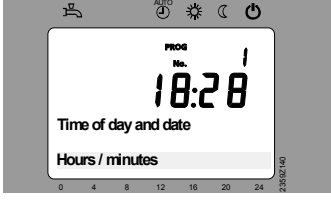
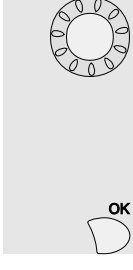
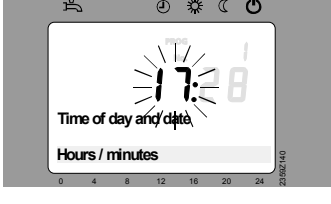

- Press *ESC* to go one step back at a time, readjusted values are not be adopted
- If no setting is made for 8 minutes, the display returns automatically to the basic display
- Operating lines may be hidden, depending on the type of controller, the configuration made and the user level

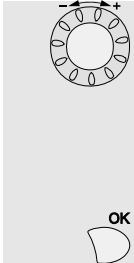
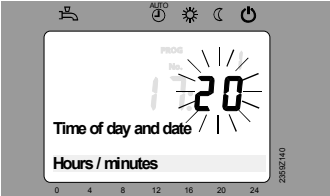
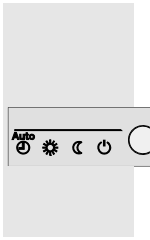
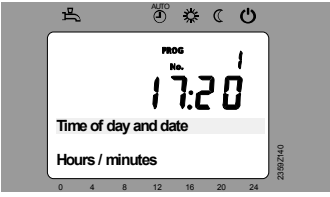
Operation	Display example	Description
<p>1</p> 		<p>Basic display. If the basic display is not shown, press the <i>ESC</i> button to return to it.</p> <p>Press <i>OK</i>.</p>
<p>2</p> 		<p>The bottom section of the display shows a number of operating pages. Turn the setting knob until operating page <i>Time of day and date</i> appears.</p> <p>Press <i>OK</i> to confirm.</p>
<p>3</p> 		<p>In the bottom section of the display, the first operating line of operating page <i>Time of day and date</i> appears. Turn the setting knob until operating line <i>Hours / minutes</i> appears.</p> <p>To confirm, press <i>OK</i>.</p>
<p>4</p> 		<p>The display shows the hours flashing. Turn the setting knob until the hours of the time of day are correct.</p> <p>To confirm, press <i>OK</i>.</p>

- 5   The display shows the minutes flashing.  
Turn the setting knob until the minutes of the time of day are correct.  
To confirm, press OK.
- 6   The settings are saved and the displays stops flashing.  
Now, you can make further settings or you press the operating mode button to return to the basic display.
- 7  Now, you see the basic display again.

Example of menu structure

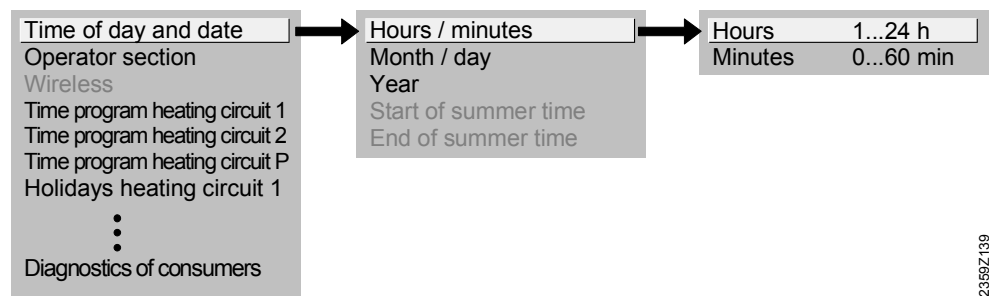

2359Z139

### 5.1.3 User levels

The user levels only allow authorized user groups to make settings. To reach the required user level, proceed as follows:

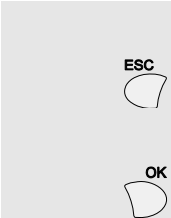
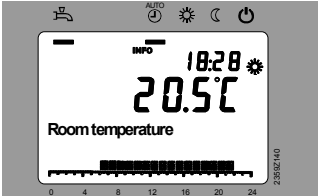
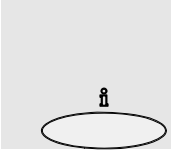
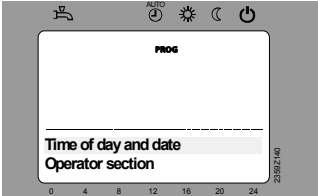
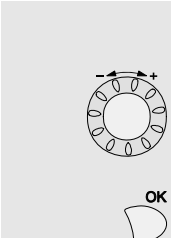
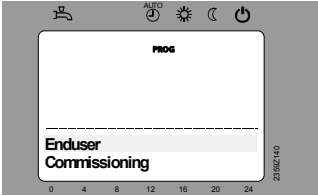
Operation	Display example	Description
1 		Basic display. If the basic display is not shown, press the ESC button to return to it.  Press OK.
2 		You are on the user level <i>End user</i> .  Press INFO for 3 seconds.
3 		You are now given a choice of user levels. Turn the setting knob until the required user level is reached.  Press OK.

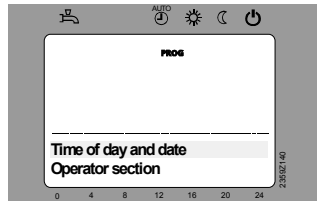
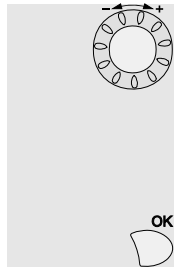

You are now on the required user level.

To reach the OEM level, the relevant code must be entered.

### Setting the structure "End user"

The example given here shows that certain user levels do not allow certain settings to be made. The example shows them highlighted. On the unit, they are hidden.

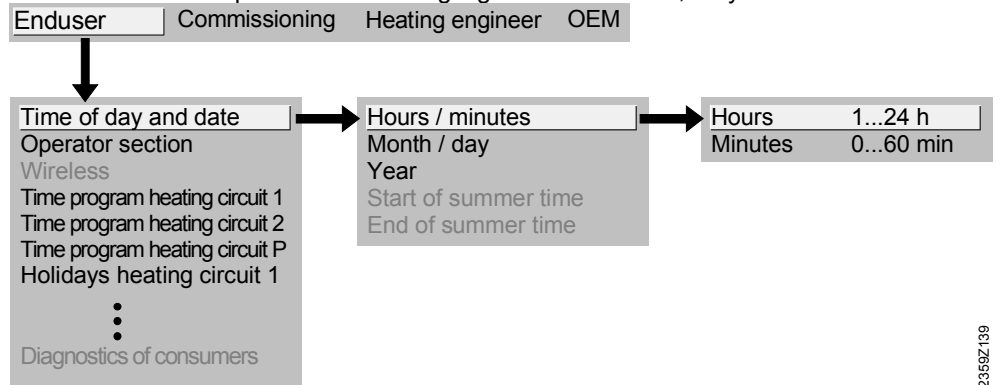

### Setting the structure "Heating engineer"

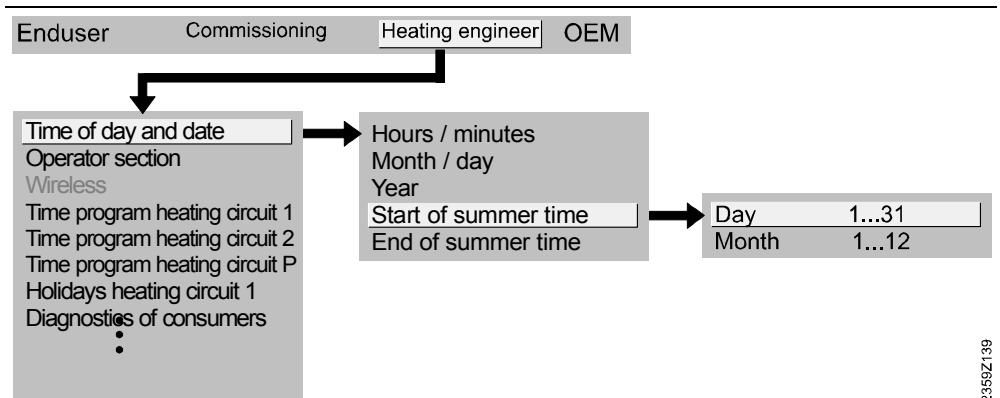

## 5.1.4 Overview of settings

The table shows all available settings up to the heating engineer level. However, certain operating lines may be hidden, depending on the type of unit.

Legend

E = end user I = commissioning F = heating engineer

BZ = Operating line

<sup>1)</sup> QAA75../78.. only

<sup>4)</sup> RVS46.543 only

Operating line	user level	Function	Default value	Min	Max	Unit
<b>Time of day and date</b>						
1	E	Hours / minutes	-	00:00	23:59	hh:mm
2	E	Day/month	-	01.01	31.12	dd.MM
3	E	Year	-	2004	2099	yyyy
5	F	Start of summertime	25.03	01.01	31.12	dd.MM
6	F	End of summertime	25.10	01.01	31.12	dd.MM
<b>Operator section</b>						
20	E	Language German   ...	German			-
22	F	Info Temporarily   Permanently	Temporarily			-
26	F	Operation lock Off   On	Off			-
27	F	Programming lock Off   On	Off			-
28	I	Direct adjustment Automatic storage   Save with acknowledgment	Save with acknowledgment			
40 <sup>1)</sup>	I	Used as Room unit 1   Room unit 2   Room unit P   Operator unit 1   Operator unit 2   Operator unit P   Service unit	Room unit 1			-
42 <sup>1)</sup>	I	Assignment device 1 Heating circuit 1   Heating circuits 1 and 2   Heating circuits 1 and P   All heating circuits	Heating circuit 1			-
44	I	Operation HC2 Commonly with HC1   Independently	Commonly with HC1			-
46	I	Operation HCP Commonly with HC1   Independently	Commonly with HC1			-
48 <sup>1)</sup>	I	Action occupancy button None   Heating circuit 1   Heating circuit 2   Commonly	Heating circuit 1			-
54 <sup>1)</sup>	F	Readjustment room sensor	0.0	-3	3	°C
70	F	Software version	-	0	99.9	-
<b>Radio</b>						
120	I	Binding No   Yes	No			
121	I	Test mode Off   On	Off			
130	I	Room unit 1 Missing   Ready   No recept'n   Change batt	-			-
131	I	Room unit 2 Missing   Ready   No recept'n   Change batt	-			-
132	I	Room unit P Missing   Ready   No recept'n   Change batt	-			-



Operating line	user level	Function	Default value	Min	Max	Unit
133	I	OutsideSens Missing   Ready   No recept'n   Change batt	-			-
134	I	Repeater Missing   Ready   No recept'n   Change batt	-			-
135	I	Operator unit 1 Missing   Ready   No recept'n   Change batt	-			
136	I	Operator unit 2 Missing   Ready   No recept'n   Change batt	-			
137	I	Operator unit P Missing   Ready   No recept'n   Change batt	-			-
138	I	Service unit Missing   Ready   No recept'n   Change batt	-			-
140	I	Delete all devices No   Yes	No			-
<b>Time prog heating circuit 1</b>						
500	E	Preselection Mo - Su   Mo - Fr   Sa - Su   Mo   Tu   We   Th   Fr   Sa   Su	Mo - Su			-
501	E	1. phase on	6:00	00:00	24:00	hh:mm
502	E	1. phase off	22:00	00:00	24:00	hh:mm
503	E	2. phase on	24:00	00:00	24:00	hh:mm
504	E	2. phase off	24:00	00:00	24:00	hh:mm
505	E	3. phase on	24:00	00:00	24:00	hh:mm
506	E	3. phase off	24:00	00:00	24:00	hh:mm
516	E	Standard values overview of settings No   Yes	No			-
<b>Time prog heating circuit 2</b>						
520	E	Preselection Mo - Su   Mo - Fr   Sa - Su   Mo   Tu   We   Th   Fr   Sa   Su	Mo - Su			-
521	E	1. phase on	6:00	00:00	24:00	hh:mm
522	E	1. phase off	22:00	00:00	24:00	hh:mm
523	E	2. phase on	24:00	00:00	24:00	hh:mm
524	E	2. phase off	24:00	00:00	24:00	hh:mm
525	E	3. phase on	24:00	00:00	24:00	hh:mm
526	E	3. phase off	24:00	00:00	24:00	hh:mm
536	E	Default values No   Yes	No			-
<b>Time program 3/HCP</b>						
540	E	Preselection Mo - Su   Mo - Fr   Sa - Su   Mo   Tu   We   Th   Fr   Sa   Su	Mo - Su			-
541	E	1. phase on	6:00	00:00	24:00	hh:mm
542	E	1. phase off	22:00	00:00	24:00	hh:mm
543	E	2. phase on	24:00	00:00	24:00	hh:mm
544	E	2. phase off	24:00	00:00	24:00	hh:mm
545	E	3. phase on	24:00	00:00	24:00	hh:mm
546	E	3. phase off	24:00	00:00	24:00	hh:mm
556	E	Default values No   Yes	No			-
<b>Time program 4/DHW</b>						
560	E	Preselection Mo - Su   Mo - Fr   Sa - Su   Mo   Tu   We   Th   Fr   Sa   Su	Mo - Su			-
561	E	1. phase on	6:00	00:00	24:00	hh:mm
562	E	1. phase off	22:00	00:00	24:00	hh:mm

Operating line	user level	Function	Default value	Min	Max	Unit
563	E	2. phase on	24:00	00:00	24:00	hh:mm
564	E	2. phase off	24:00	00:00	24:00	hh:mm
565	E	3. phase on	24:00	00:00	24:00	hh:mm
566	E	3. phase off	24:00	00:00	24:00	hh:mm
576	E	Default values No   Yes	No			-
<b>Time program 5</b>						
600	E	Preselection Mo - Su   Mo - Fr   Sa - Su   Mo   Tu   We   Th   Fr   Sa   Su	Mo - Su			-
601	E	1. phase on	6:00	00:00	24:00	hh:mm
602	E	1. phase off	22:00	00:00	24:00	hh:mm
603	E	2. phase on	24:00	00:00	24:00	hh:mm
604	E	2. phase off	24:00	00:00	24:00	hh:mm
605	E	3. phase on	24:00	00:00	24:00	hh:mm
606	E	3. phase off	24:00	00:00	24:00	hh:mm
616	E	Default values No   Yes	No			-
<b>Holidays heating circuit 1</b>						
641	E	Preselection Period 1   Period 2   Period 3   Period 4   Period 5   Period 6   Period 7   Period 8	Period 1			-
642	E	Start	--:--	01.01	31.12	dd.MM
643	E	End	--:--	01.01	31.12	dd.MM
648	E	Operating level Frost protection   Reduced	Frost protection			-
<b>Holidays heating circuit 2</b>						
651	E	Preselection Period 1   Period 2   Period 3   Period 4   Period 5   Period 6   Period 7   Period 8	Period 1			-
652	E	Start	--:--	01.01	31.12	dd.MM
653	E	End	--:--	01.01	31.12	dd.MM
658	E	operating level Frost protection   Reduced	Frost protection			-
<b>Holidays heating circuit P</b>						
661	E	Preselection Period 1   Period 2   Period 3   Period 4   Period 5   Period 6   Period 7   Period 8	Period 1			-
662	E	Start	--:--	01.01	31.12	dd.MM
663	E	End	--:--	01.01	31.12	dd.MM
668	E	Operating level Frost protection   Reduced	Frost protection			-
<b>Heating circuit 1</b>						
710	E	Comfort cooling setpoint	20.0	Operating line 712	Operating line 716	°C
712	E	Reduced setpoint	16	Operating line 714	Operating line 710	°C
714	E	Frost protection setpoint	10.0	4	Operating line 712	°C
716	F	Comfort setpoint maximum	35.0	Operating line 710	35	°C
720	E	Heating curve slope	1.50	0.10	4.00	-
721	F	Heating curve displacement	0.0	-4.5	4.5	°C
726	F	Heating curve adaption Off   On	Off			-
730	E	Summer/winter heating limit	18	-- -- / 8	30	°C

Operating line	user level	Function	Default value	Min	Max	Unit
732	F	24-hour heating limit	-3	--- / -10	10	°C
740	I	Flow temp setpoint min	8	8	Operating line 741	°C
741	I	Flow temp setpoint max	80	Operating line 740	95	°C
750	F	Room influence	20	--- / 1	100	%
760	F	Room temp limitation	1	--- / 0.5	4	°C
770	F	Boost heating	5	--- / 0	20	°C
780	F	Quick setback Off ; Down to reduced setpoint ; Down to frost prot setp	Down to reduced setpoint			-
790	F	Optimum start control max	0	0	360	min
791	F	Optimum top control max	0	0	360	min
800	F	Reduced setp increase start	---	--- / -30	10	°C
801	F	Reduced setp increase end	-15	-30	Operating line 800	°C
820	F	Overtemp prot pump circuit Off ; On	On			-
830	F	Mixing valve boost	5	0	50	°C
832	F	Actuator type 2-position ; 3-position	3-position			-
833	F	Switching differential 2-pos	2	0	20	°C
834	F	Actuator running time	120	30	873	s
850	I	Floor curing function Off ; Functional heating ; Curing heating ; Functional/ curing heating ; Curing/functional heating ; Manually	Off			-
851	I	Floor curing setp manual	25	0	95	°C
861	F	Excess heat draw Off ; Heating mode ; Always	Always			-
870	F	With buffer storage tank No ; Yes	Yes			-
872	F	With primary controller / system pump No ; Yes	Yes			-
900	F	Optg mode changeover None ; Protection ; Reduced ; Comfort ; Automatic	Protection mode			-
<b>Cooling circuit 1</b>						
901	E	Operating mode Off ; Automatic	Automatically			-
902	E	Comfort cooling setpoint	24.0	15	40	°C
907	E	release 24h/day ; Time programs HCs ; Time program 5	24 h/day			-
908	I	Flow setpoint at OT 25°C	20	8	35	°C
909	I	Flow setpoint at OT 35°C	16	8	35	°C
912	I	Cooling limit at OT (outside temperature)	20	--- / 8	355	°C
913	F	Locking period at end of heating	24	--- / 8	100	h
918	F	Start of summer compensation at OT	26	20	35	°C
919	F	End of summer compensation at OT	35	20	35	°C
920	F	Summer compensation setpoint increase	4	--- / 1	10	°C
923	I	Flow setpoint min. OT 25°C	18	8	35	°C
924	I	Flow setpoint min. OT 35°C	18	8	35	°C
928	F	Room influence	80	--- / 1	100	%
932	F	Room temp limitation	0.5	--- / 0.5	4	°C
938	F	Mixing valve cooling offset	0	0	20	°C
939	F	Actuator type 2-position ; 3-position	3-position			-

Operating line	user level	Function	Default value	Min	Max	Unit
940	F	Switching differential 2-pos	2	0	20	°C
941	F	Actuator running time	120	30	873	s
945	F	Mixing valve in heating mode Control ; Open	Controls			
946	F	Dewpt monitor locking time	60	--- / 10	600	min
947	F	Flow setpt increase hygro	3	--- / 1	10	°C
948	F	Start flow increase at R.H.	60	0	100	%
950	I	Flow temp diff dewpoint	2	--- / 0	10	°C
962	F	With buffer storage tank No ; Yes	No			
963	F	With primary controller / system pump No ; Yes	No			
969	I	Optg mode changeover None ; Off ; Automatic	Off			
<b>Heating circuit 2</b>						
1010	E	Comfort cooling setpoint	20.0	Operating line 1012	Operating line 1016	°C
1012	E	Reduced setpoint	16	Operating line 1014	Operating line 1010	°C
1014	E	Frost protection setpoint	10.0	4	Operating line 1012	°C
1016	F	Comfort setpoint maximum	35.0	Operating line 1010	35	°C
1020	E	Heating curve slope	1.50	0.10	4.00	-
1021	F	Heating curve displacement	0.0	-4.5	4.5	°C
1026	F	Heating curve adaption Off ; On	Off			-
1030	E	Summer/winter heating limit	18	--- / 8	30	°C
1032	F	24-hour heating limit	-3	--- / -10	10	°C
1040	I	Flow temp setpoint min	8	8	Operating line 1041	°C
1041	I	Flow temp setpoint max	80	Operating line 1040	95	°C
1050	F	Room influence	20	--- / 1	100	%
1060	F	Room temp limitation	1	--- / 0.5	4	°C
1070	F	Boost heating	5	--- / 0	20	°C
1080	F	Quick setback Off ; Down to reduced setpoint ; Down to frost prot setp	Down to reduced setpoint			-
1090	F	Optimum start control max	0	0	360	min
1091	F	Optimum top control max	0	0	360	min
1100	F	Reduced setp increase start	---	--- / -30	10	°C
1101	F	Reduced setp increase end	-15	-30	Operating line 1100	°C
1120	F	Overtemp prot pump circuit Off ; On	On			-
1130	F	Mixing valve boost	5	0	50	°C
1132	F	Actuator type 2-position ; 3-position	3-position			-
1133	F	Switching differential 2-pos	2	0	20	°C
1134	F	Actuator running time	120	30	873	s
1150	F	Floor curing function Off ; Functional heating ; Curing heating ; Functional/ curing heating ; Curing/functional heating ; Manually	Off			-
1151	F	Floor curing setp manual	25	0	95	°C

Operating line	user level	Function	Default value	Min	Max	Unit
1161	F	Excess heat draw Off ; Heating mode ; Always	Always			
1170	F	With buffer storage tank No ; Yes	Yes			-
1172	F	With primary controller / system pump No ; Yes	Yes			
1200	F	Optg mode changeover None ; Protection ; Reduced ; Comfort ; Automatic	Protection mode			
<b>Heating circuit P</b>						
1300	E	Operating mode Protection ; Automatic ; Reduced ; Comfort	Automatically			-
1310	E	Comfort cooling setpoint	20.0	Operating line 1312	Operating line 1316	°C
1312	E	Reduced setpoint	16	Operating line 1314	Operating line 1310	°C
1314	E	Frost protection setpoint	10.0	4	Operating line 1312	°C
1316	F	Comfort setpoint maximum	35.0	Operating line 1310	35	°C
1320	E	Heating curve slope	1.50	0.10	4.00	-
1321	F	Heating curve displacement	0.0	-4.5	4.5	°C
1326	F	Heating curve adaption Off ; On	Off			-
1330	E	Summer/winter heating limit	18	--- / 8	30	°C
1332	F	24-hour heating limit	-3	--- / -10	10	°C
1340	F	Flow temp setpoint min	8	8	Operating line 1341	°C
1341	F	Flow temp setpoint max	80	Operating line 1340	95	°C
1350	F	Room influence	20	--- / 1	100	%
1360	F	Room temp limitation	1	--- / 0.5	4	°C
1370	F	Boost heating	5	--- / 0	20	°C
1380	F	Quick setback Off ; Down to reduced setpoint ; Down to frost prot setp	Down to reduced setpoint			-
1390	F	Optimum start control max	0	0	360	min
1391	F	Optimum top control max	0	0	360	min
1400	F	Reduced setp increase start	---	--- / -30	10	°C
1401	F	Reduced setp increase end	-15	-30	Operating line 1400	°C
1420	F	Overtemp prot pump circuit Off ; On	On			-
1450	I	Floor curing function Off ; Functional heating ; Curing heating ; Functional/ curing heating ; Curing/functional heating ; Manually	Off			-
1451	I	Floor curing setp manual	25	0	95	°C
1455	F	Floor curing setp current	0	0	95	°C
1456	F	Floor curing day current	0	0	32	
1457	F	Floor curing days complete	0	0	32	
1461	F	Excess heat draw Off ; Heating mode ; Always	Always			
1470	F	With buffer storage tank No ; Yes	Yes			-
1472	F	With primary controller / system pump No ; Yes	Yes			

Operating line	user level	Function	Default value		Max	Unit
				Min		
1500	F	Optg mode changeover None ; Protection ; Reduced ; Comfort ; Automatic	Protection mode			
<b>DHW</b>						
1610	E	Nominal setpoint	55	Operating line 1612	BZ 1614 OEM	°C
1612	F	Reduced setpoint	40	8	Operating line 1610	°C
1620	I	release 24h/day ; Time programs HCs ; Time program 4/DHW	Time programs HCs			-
1630	I	Charging priority Absolute ; Shifting ; None ; MC shifting, PC absolute	MC shifting, PC absolute			-
1640	F	Legionella function Off ; Periodically ; Fixed weekday	Fixed weekday			-
1641	F	Legionella funct periodically	3	1	7	Days
1642	F	Legionella funct weekday Monday ; Tuesday ; Wednesday ; Thursday ; Friday ; Saturday ; Sunday	Monday			
1644	F	Legionella function time	---	--- / 00:00	23:50	hh:mm
1645	F	Setpoint of Legionella function	65	55	95	°C
1646	F	Legionella function dwelling time	30	--- / 10	360	min
1647 <sup>4)</sup>	F	Legionella funct circ pump Off ; On	On			-
1660 <sup>4)</sup>	F	Circulating pump release Time program 3/HCP ; DHW release ; Time program 4/DHW ; Time program 5	DHW release			-
1661 <sup>4)</sup>	F	Circulating pump cycling Off ; On	On			-
1663 <sup>4)</sup>	F	Circulation setpoint	45	8	80	°C
<b>Pump Hx</b>						
2010	F	H1 Excess heat draw Off ; On	On			
2012	F	H1 with buffer storage tank No ; Yes	Yes			-
2014	F	H1 prim contr/system pump No ; Yes	Yes			-
2015	F	H1 Refrig demand 2-pipe system ; 4-pipe system	2-pipe system			
2035	F	H2 Excess heat draw Off ; On	On			
2037	F	H2 with buffer storage tank No ; Yes	Yes			-
2039	F	H2 prim contr/system pump No ; Yes	Yes			-
2040	F	H2 Refrig demand 2-pipe system ; 4-pipe system	2-pipe system			
<b>Primary controller / system pump</b>						
2150	I	Primary controller / system pump Before buffer st tank ; After buffer st tank	After buffer st tank			-
<b>Solar</b>						
3810 <sup>4)</sup>	F	Temp diff on	8	0	40	°C
3811 <sup>4)</sup>	F	Temp diff off	4	0	40	°C
3812 <sup>4)</sup>	F	Charg temp min DHW st tank	---	--- / 8	95	°C
3831 <sup>4)</sup>	F	Min run time collector pump	20	5	120	s
3834 <sup>4)</sup>	F	Collector start funct gradient	---	--- / 1	20	Min/°C

Operating line	user level	Function	Default value	Min	Max	Unit
3840 <sup>4)</sup>	F	Collector frost protection	---	--- / -20	5	°C
3850 <sup>4)</sup>	F	Collector overtemp prot	---	--- / 30	350	°C
3860 <sup>4)</sup>	F	Evaporation heat carrier	---	--- / 60	350	°C
3880 <sup>4)</sup>	F	Antifreeze None ; Ethylene glycol ; Propylene glycol ; Ethyl and propyl glycol	None			
3881 <sup>4)</sup>	F	Antifreeze concentration	30	1	100	%
3884 <sup>4)</sup>	F	Pump capacity	200	10	1500	l/h
<b>DHW storage tank</b>						
5020 <sup>4)</sup>	F	Flow setpoint boost	16	0	30	°C
5021 <sup>4)</sup>	F	Increase of transfer boost	8	0	30	°C
5022 <sup>4)</sup>	F	Type of charging with B3 ; With B3 and B31 ; Legio B3 and B31	With B3 and B31			
5050 <sup>4)</sup>	F	Charging temperature max	80	8	BZ 5051 OEM	°C
5055 <sup>4)</sup>	F	Recooling temp	80	8	95	°C
5056 <sup>4)</sup>	F	Recooling heat gen/HCs Off ; On	Off			-
5057 <sup>4)</sup>	F	Recooling collector Off ; Summer ; Always	Off			-
5060 <sup>4)</sup>	F	electric immersion heater:operating mode Substitute ; Summer ; Always	Substitute			-
5061 <sup>4)</sup>	F	Electric immersion heater release 24h/day ; DHW release ; Time program4/ DHW	DHW release			-
5062 <sup>4)</sup>	F	EI immersion heater control External thermostat ; DHW sensor	DHW sensor			-
5085 <sup>4)</sup>	F	Excess heat draw Off ; On	On			-
5090 <sup>4)</sup>	F	With buffer storage tank No ; Yes	No			
5092 <sup>4)</sup>	F	With primary controller / system pump No ; Yes	No			
5093 <sup>4)</sup>	F	With solar integration No ; Yes	Yes			
<b>Instantaneous DHW heater</b>						
5544 <sup>4)</sup>	F	Actuator running time	60	7.5	480	s
<b>Configuration</b>						
5710	I	Heating circuit 1 Off ; On	On			-
5711	I	Cooling circuit 1 Off ; 4-pipe system ; 2-pipe system				-
5712	I	Use of mixing valve 1 Heating ; Cooling ; Heating and cooling	Heating and cooling			-
5715	I	Heating circuit 2 Off ; On	Off			-
5730 <sup>4)</sup>	I	DHW sensor B3 Sensor ; Thermostat	Sensors			-
5731 <sup>4)</sup>	I	DHW control element Q3 None ; Charging pump ; Diverting valve	Charging pump			-
5890 <sup>4)</sup>	I	Relay output QX1 None ; Circulating pump Q4 ; EI imm heater DHW K6 ; Collector pump Q5 ; H1 pump Q15 ; Alarm output K10 ; 2nd pump speed HC1 Q21 ; 2nd pump speed HC2 Q22 ; 2nd pump speed HCP Q23 ; Heat circuit pump HCP Q20 ; H2 pump Q18 ; System pump Q14 ; Scheduler 5	None			-

Operating line	user level	Function	Default value		Max	Unit
				Min		
		K13 ; DHW mixing pump Q35 ; DHW item circ pump Q33 ; Heat request K27 ; Refrig request K28 ; Air dehumidifier K29 ; Diverting valve, cooling Y21				
5930 <sup>4)</sup>	I	Sensor input BX1 None ; DHW sensor B31 ; Collector sensor B6 ; DHW circulation sensor B39 ; DHW charging sensor B36 ; Solar flow sensor B63 ; Solar return sensor B64	None			-
5931 <sup>4)</sup>	I	Sensor input BX2 None ; DHW sensor B31 ; Collector sensor B6 ; DHW circulation sensor B39 ; DHW charging sensor B36 ; Solar flow sensor B63 ; Solar return sensor B64	None			-
5950	I	Function input H1 Optg mode changeover HCs + DHW ; Optg mode changeover HCs ; Optg mode changeover HC1 ; Optg mode changeover HC2 ; Optg mode changeover HCP ; Error/alarm message ; Min flow temp setpoint ; Excess heat discharge ; Dewpoint monitor ; Flow temp. setpt increase, hygro ; Refrig request ; Heat request 10V ; Refrig. request 10V ; Pressure measurement 10V ; Rel. room humidity 10V ; Room temperature 10V	Optg mode changeover HCs+DHW			-
5951	I	Contact type H1 NC ; NO	N/O			-
5952	I	Function value, contact type H1	70	8	130	°C
5953	I	Voltage value 1, H1	0	0	10	Volt
5954	I	Function value 1, H1	0	-100	500	-
5955	I	Voltage value 2, H1	10	0	10	Volt
5956	I	Function value 2, H1	70	-100	500	-
6014	I	Function mixing group 1 Heating circuit 1 ; Prim contr/system pump ; DHW primary controller <sup>4)</sup> ; Instantaneous DHW heater <sup>4)</sup> ; Cooling circuit 1 ; Heating circuit / Cooling circuit 1	Heating circuit			-
6020	I	Function extension module 1 No function ; Multifunctional ; Heating circuit 2 ; Solar DHW <sup>4)</sup> ; Prim contr/system pump ; DHW primary controller <sup>4)</sup> ; Instantaneous DHW heater <sup>4)</sup> ; Cooling circuit 1	None			-
6021	I	Function extension module 2 No function ; Multifunctional ; Heating circuit 2 ; Solar DHW <sup>4)</sup> ; Prim contr/system pump ; DHW primary controller <sup>4)</sup> ; Instantaneous DHW heater <sup>4)</sup> ; Cooling circuit 1	None			-
6030	I	Relay output QX21 None ; Circulating pump Q4 <sup>4)</sup> ; None ; Circulating pump Q4 <sup>4)</sup> ; EI imm heater DHW K6 ; Collector pump Q5 <sup>4)</sup> ; H1 pump Q15 ; Alarm output K10 ; 2nd pump speed HC1 Q21 ; 2nd pump speed HC2 Q22 ; 2nd pump speed HCP Q23 ; Heat circuit pump HCP Q20 ; H2 pump Q18 ; System pump Q14 ; Scheduler 5 K13 ; DHW mixing pump Q35 <sup>4)</sup> ; DHW item circ pump Q33 <sup>4)</sup> ; Heat request K27 ; Refrig request K28 ; Air dehumidifier K29 ; Diverting valve, cooling Y21	None			
6031	I	Relay output QX22 None ; Circulating pump Q4 <sup>4)</sup> ; EI imm heater DHW K6 ; Collector pump Q5 <sup>4)</sup> ; H1 pump Q15 ; Alarm output K10 ; 2nd pump speed HC1 Q21 ; 2nd pump speed HC2 Q22 ; 2nd pump speed HCP Q23 ; Heat circuit pump HCP Q20 ; H2 pump Q18 ; System pump Q14 ; Scheduler 5 K13 ; DHW mixing pump Q35 <sup>4)</sup> ; DHW item circ pump Q33 <sup>4)</sup> ; Heat request K27 ; Refrig	None			



Operating line	user level	Function	Default value		Max	Unit
				Min		
		request K28 ; Air dehumidifier K29 ; Diverting valve, cooling Y21				
6032	I	Relay output QX23 None ; Circulating pump Q4 <sup>4)</sup> ; None ; Circulating pump Q4 <sup>4)</sup> ; El imm heater DHW K6 ; Collector pump Q5 <sup>4)</sup> ; H1 pump Q15 ; Alarm output K10 ; 2nd pump speed HC1 Q21 ; 2nd pump speed HC2 Q22 ; 2nd pump speed HCP Q23 ; Heat circuit pump HCP Q20 ; H2 pump Q18 ; System pump Q14 ; Scheduler 5 K13 ; DHW mixing pump Q35 <sup>4)</sup> ; DHW item circ pump Q33 <sup>4)</sup> ; Heat request K27 ; Refrig request K28 ; Air dehumidifier K29 ; Diverting valve, cooling Y21	None			
6040 <sup>4)</sup>	I	Sensor input BX21 None ; DHW sensor B31 ; Collector sensor B6 ; DHW circulation sensor B39 ; DHW charging sensor B36 ; Solar flow sensor B63 ; Solar return sensor B64	None			
6041 <sup>4)</sup>	I	Sensor input BX22 None ; DHW sensor B31 ; Collector sensor B6 ; DHW circulation sensor B39 ; DHW charging sensor B36 ; Solar flow sensor B63 ; Solar return sensor B64	None			
6046	I	Function input H2 Optg mode changeover HCs + DHW ; Optg mode changeover HCs ; Optg mode changeover HC1 ; Optg mode changeover HC2 ; Optg mode changeover HCP ; Error/alarm message ; Min flow temp setpoint ; Excess heat discharge ; Dewpoint monitor ; Flow temp. setpt increase, hygro ; Refrig request ; Heat request 10V ; Refrig. request 10V ; Pressure measurement 10V ; Rel. room humidity 10V ; Room temperature 10V	Optg mode changeover HCs+DHW			
6047	I	Contact type H2 NC ; NO	N/O			-
6048	I	Function value, contact H2	70	8	130	°C
6049	I	Voltage value 1, H2	0	0	10	Volt
6050	I	Function value 1, H2	0	-100	500	-
6051	I	Voltage value 2, H2	10	0	10	Volt
6052	I	Function value 2, H2	70	-100	500	-
6097 <sup>4)</sup>	F	Sensor type collector NTC 10k ; Platinum 1000	NTC 10k			
6098 <sup>4)</sup>	F	Readjustm collector sensor	0	-20	20	°C
6100	F	Readjustm outside sensor	0	-3.0	3.0	°C
6110	F	Time constant building	15	0	50	h
6120	F	Frost protection for the plant Off ; On	Off			-
6128	F	Heat request below OT	---	--- / -50	50	°C
6129	F	Heat request above OT	---	--- / -50	50	°C
6131 <sup>4)</sup>	F	Heat req in economy mode Off ; On DHW ; On	Off			
6135	F	Air dehumidifier Off ; On	Off			
6136	F	Air dehumidifier enable 24h/day ; Time progr. heating circuit ; Time program 5	24 h/day			
6137	F	Air dehumidifier r.h. EIN	55	0	100	%
6138	F	Air dehumidifier r.h. SD	5	2	50	%
6200	I	Save sensors No ; Yes	No			-

Operating line	user level	Function	Default value	Min	Max	Unit
6205	F	Reset to default parameters No ; Yes	No			-
6212 <sup>4)</sup>	I	Check-No. heat source 1	-	0	199999	-
6215	I	Check-No. storage tank	-	0	199999	-
6217	I	Check-No. heating circuits	-	0	199999	-
6220	F	Software version	-	0	99.9	-
<b>LPB-System</b>						
6600	I	Device address	1	0	16	-
6601	F	Segment address	0	0	14	-
6604	F	Bus power supply function Off ; Automatically	Automatically			-
6605	F	Bus power supply state Off ; On	On			-
6621	F	Summer changeover Locally ; Centrally	Locally			-
6623	F	Optg mode changeover Locally ; Centrally	Centrally			-
6625	F	Assignment of DHW heating Local HCs ; All HCs in segment ; All HCs in system	All HCs in system			-
6627	F	Refrigeration demand Locally ; Centrally	Locally			-
6640	I	Clock mode Autonomously ; Slave without remote ; Slave with remote setting ; Master	Autonomously			-
6650	F	Outside temp source	0	0	239	-
<b>Errors</b>						
6710	I	Reset alarm relay No ; Yes	No			-
6740	F	Flow temp 1 alarm	---	--- / 10	240	min
6741	F	Flow temp 2 alarm	---	--- / 10	240	min
6745 <sup>4)</sup>	F	DHW charging alarm	---	--- / 1	48	h
6746	F	Flow temp alarm, cooling 1	---	--- / 10	240	min
6800	F	History 1	-			
	F	Error code 1	-	0	255	-
6802	F	History 2	-			
	F	Error code 2	-	0	255	-
6804	F	History 3	-			
	F	Error code 3	-	0	255	-
6806	F	History 4	-			
	F	Error code 4	-	0	255	-
6808	F	History 5	-			
	F	Error code 5	-	0	255	-
6810	F	History 6	-			
	F	Error code 6	-	0	255	-
6812	F	History 7	-			
	F	Error code 7	-	0	255	-
6814	F	History 8	-			
	F	Error code 8	-	0	255	-
6816	F	History 9	-			
	F	Error code 9	-	0	255	-

Operating line	user level	Function	Default value	Min	Max	Unit
6818	F	History 10	-			
	F	Error code 10	-	0	255	-
<b>Maintenance / special operation</b>						
7044	F	Maintenance interval	- - -	- - - / 1	240	Months
7045	F	Time since maintenance	0	0	240	Months
7119 <sup>4)</sup>	F	Economy function Locked   released	Locked			-
7120 <sup>4)</sup>	E	Economy mode Off   On	Off			-
7140	E	manual operation Off   On	Off			-
7150	I	Simulation outside temperature	-	-50.0	50	°C
7170	I	Telephone customer service				-
<b>Input / output test</b>						
7700	I	Relay test No test   Everything off   DHW pump Q3   Heating circuit pump Q2   Heating circ mix valve op Y1   Heat circ mix valve cl Y2   Relay output QX1 <sup>4)</sup>   Relay output QX21 module 1   Relay output QX22 module 1   Relay output QX23 module 1   Relay output QX21 module 2   Relay output QX22 module 2   Relay output QX23 module 2	No test			-
7730	I	Outside temp B9	-	-50.0	50	°C
7732	I	Flow temp B1	-	0.0	140	°C
7750 <sup>4)</sup>	I	DHW temp B3	-	0.0	140	°C
7820 <sup>4)</sup>	I	Sensor temp BX1	-	-28.0	350	°C
7821 <sup>4)</sup>	I	Sensor temp BX2	-	-28.0	350	°C
7830 <sup>4)</sup>	I	Sensor temp BX21 module 1	0	-28	350	°C
7831 <sup>4)</sup>	I	Sensor temp BX22 module 1	0	-28	350	°C
7832 <sup>4)</sup>	I	Sensor temp BX21 module 2	0	-28	350	°C
7833 <sup>4)</sup>	I	Sensor temp BX22 module 2	0	-28	350	°C
7840	I	Voltage signal H1	-	0	10	Volt
7841	I	Contact state H1 Open   Closed	-			-
7845	I	Voltage signal H2	0	0	10	Volt
7846	I	Contact state H2 Open   Closed	-			-
<b>State</b>						
8000	I	State of heating circuit 1	-			-
8001	I	State of heating circuit 2	-			-
8002	I	State heating circuit P	-			-
8003	I	State of DHW	-			-
8004	I	State of cooling circuit 1	-			-
8007 <sup>4)</sup>	I	State of solar	-			-
<b>Diagnostics, heat generation</b>						
8510 <sup>4)</sup>	I	Collector temp 1	-	-28.0	350	°C
8511 <sup>4)</sup>	I	Collector temp 1 max	0	-28.0	350	°C
8512 <sup>4)</sup>	I	Collector temp 1 min	0	-28.0	350	°C
8513 <sup>4)</sup>	I	dT collector 1/DHW	-	-168.0	350	°C
8519 <sup>4)</sup>	I	Solar flow temp	0	-28.0	350	°C
8520 <sup>4)</sup>	I	Solar return temp	0	-28.0	350	°C

Operating line	user level	Function	Default value	Min	Max	Unit
8526 <sup>4)</sup>	E	24-hour yield solar energy	0	0	999.9	kWh
8527 <sup>4)</sup>	E	Total yield solar energy	0	0	9999999.9	kWh
8530 <sup>4)</sup>	F	Hours run solar yield	-	0	65535	h
8531 <sup>4)</sup>	F	Hours run collect overtemp	-	0	65535	h
Diagnostics, consumers						
8700	I	Outside temperature (OT)	-	-50.0	50.0	°C
8703	I	Outside temp attenuated	-	-50.0	50.0	°C
8704	I	Outside temperature composite	-	-50.0	50.0	°C
8720	I	Relative room humidity	-	0	100	%
8721	I	Room temperature	-	0	50.0	°C
8722	I	Dewpoint temperature 1	-	0	50.0	°C
8730	I	Heating circuit pump Q2 Off   On	-			-
8731	I	Heating circ mix valve op Y1 Off   On	-			-
8732	I	Heat circ mix valve cl Y2 Off   On	-			-
8740	I	Room temp 1	-	0.0	50.0	°C
8741	I	Room setpoint 1	-	4.0	35.0	°C
8743	I	Flow temperature 1	-	0.0	140.0	°C
8744	I	Flow temp setpoint 1	-	0.0	140.0	°C
8751	I	Cooling circuit pump 1 Off   On	-			
8752	I	Cooling circuit mixing valve 1 Open Off   On	-			
8753	I	Cooling circuit mixing valve 1 Closed Off   On	-			
8754	I	Cooling diverting valve 1 Off   On	-			
8756	I	Flow temperature, cooling 1	-	0	140	°C
8757	I	Flow temperature, cooling 1	-	0	140	°C
8760	I	Heating circuit pump 2 Off   On	-			-
8761	I	Heat circ mix valve 2 open Off   On	-			-
8762	I	Heat circ mix valve 2 close Off   On	-			-
8770	I	Room temp 2	-	0.0	50	°C
8771	I	Room setpoint 2	-	4.0	35	°C
8773	I	Flow temperature 2	-	0.0	140	°C
8774	I	Flow temp setpoint 2	-	0.0	140	°C
8800	I	Room temp P	-	0.0	50	°C
8801	I	Room setpoint P	-	4.0	35	°C
8803	I	Flow temp setpoint P	-	0.0	140	°C
8820 <sup>4)</sup>	I	DHW pump Q3 Off   On	-			-
8830	I	DHW temp 1	-	0.0	140	°C
8831	I	DHW temp setpoint	-	8.0	80	°C
8832 <sup>4)</sup>	I	DHW temp 2	-	0.0	140	°C
8835 <sup>4)</sup>	I	DHW circulation temp	-	0.0	140	°C
8836 <sup>4)</sup>	I	DHW charging temp	0	0	140	°C

Operating line	user level	Function	Default value	Min	Max	Unit
8850 <sup>4)</sup>	I	DHW primary controller temp	0	0	140	°C
8851 <sup>4)</sup>	I	DHW primary controller setp	0	0	140	°C
8852 <sup>4)</sup>	I	Instant DHW heater temp	0	0	140	°C
8853 <sup>4)</sup>	I	Instant DHW heater setpoint	0	0	140	°C
8930	I	Primary controller temp	-	0.0	140.0	°C
8931	I	Primary controller setpoint	-	0.0	140.0	°C
8950 <sup>4)</sup>	I	Common flow temp	-	0.0	140.0	°C
8951 <sup>4)</sup>	I	Common flow temp setpoint	-	0.0	140.0	°C
8957 <sup>4)</sup>	I	Common flow temp setpoint refrig	0	0	140	°C
9000	I	Flow temperature setpoint H1	-	5.0	130.0	°C
9001	I	Flow temp setpoint H2	-	5.0	130.0	°C
9005	I	Water pressure H1	-	0.0	10.0	bar
9006	I	Water pressure H2	-	0.0	10.0	bar
9031 <sup>4)</sup>	I	Relay output QX1 Off   On	-			-
9050	I	Relay output QX21 module 1 Off   On	-			-
9051	I	Relay output QX22 module 1 Off   On	-			-
9052	I	Relay output QX23 module 1 Off   On	-			-
9053	I	Relay output QX21 module 2 Off   On	-			-
9054	I	Relay output QX22 module 2 Off   On	-			-
9055	I	Relay output QX23 module 2 Off   On	-			-

## 5.2 AVS37.390

### 5.2.1 Operation

#### Operating elements

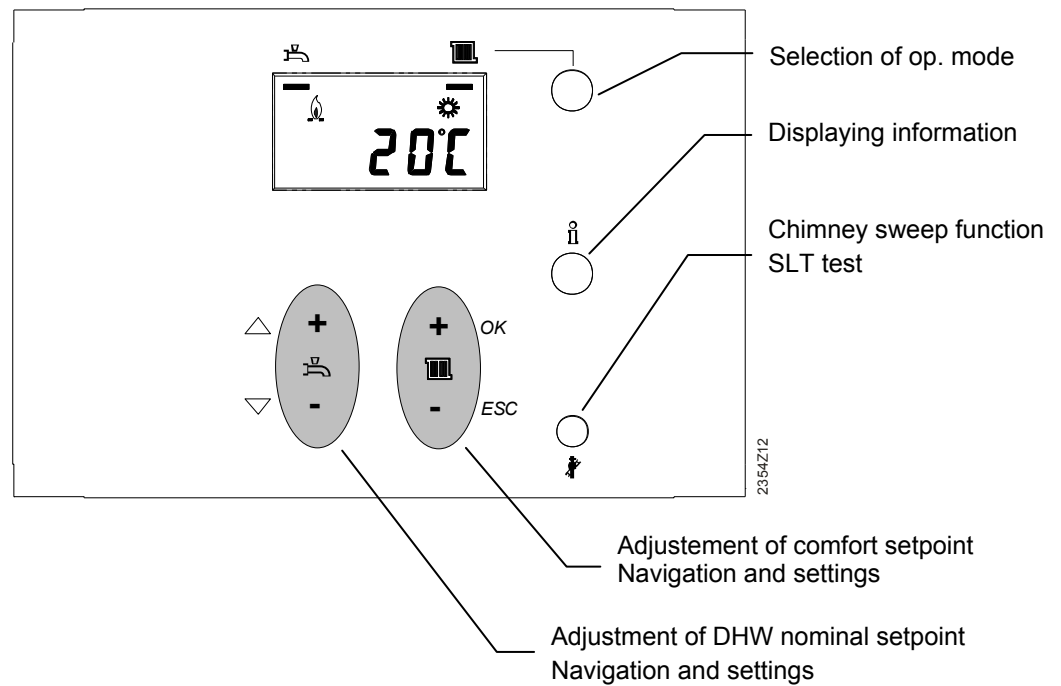

The above illustration shows an example of the front of an operator unit (not supplied as standard).

#### Display options

- |                                      |                                 |
|--------------------------------------|---------------------------------|
| Heating to Comfort setpoint          | Burner in operation             |
| Heating to Reduced setpoint          | Error messages                  |
| Heat generation mode, heating active | Maintenance / special operation |
| Heat generation mode, DHW active     |                                 |

#### Display

Display of all symbols and segments.

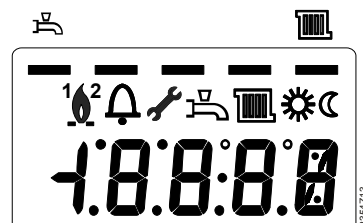

#### Selecting the operating mode

Press the button to switch from heating mode on / off to DHW heating, and vice versa. The selection made is indicated by a bar which appears below the respective symbol.



## Adjusting the room temperature setpoint

Press the + / - buttons to increase or decrease the **Comfort setpoint** ☀

For the **Reduced setpoint** ☹

- Press OK
- Select the operating line for the "Reduced setpoint"

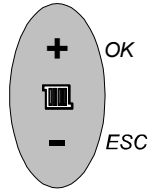

After each readjustment, wait at least 2 hours, allowing the room temperature to adapt.

## Adjusting the nominal DHW setpoint

Press the + / - buttons to increase or decrease the nominal DHW setpoint.

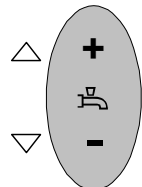

## Displaying information

Various data can be displayed by pressing the info button. The display alternates, showing the value and the info no.

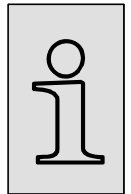
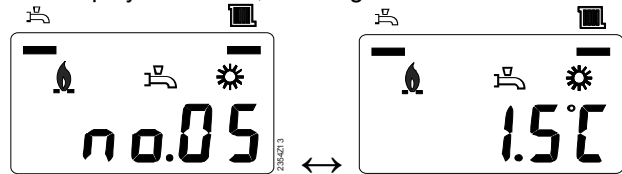

- |                                  |          |                            |
|----------------------------------|----------|----------------------------|
| - No. 1 Boiler temperature       | - No. 10 | State of heating circuit 1 |
| - No. 2 Outside temperature (OT) | - No. 11 | State of heating circuit 2 |
| - No. 3 DHW temperature          | - No. 12 | State of DHW               |
| - No. 4 Flow temperature 1       | - No. 13 | State of boiler            |
| - No. 5 Flow temperature 2       | - No. 14 | State of solar             |

## Exception

In exceptional cases, the basic display shows one of the following symbols:

### Error messages

If this symbol appears, an error in the plant has occurred. The display shows letter "c", followed by the error no.

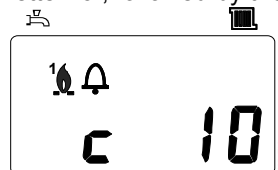

### Maintenance or special operation

If this symbol appears, a maintenance alarm is delivered or the plant has changed to special mode. The display shows letter "c", followed by the message no.

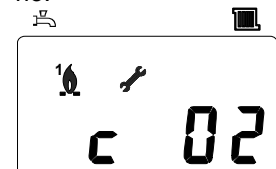

## Chimney sweep function

To start the chimney sweep function, press the button for a moment (< 3 seconds). This function produces the operating state required to make emission measurements (flue gas).

### 3.1.2 Programming

#### Setting principle

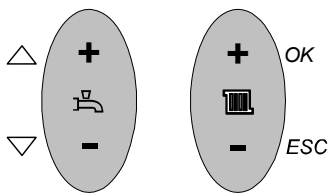

Settings that cannot be made directly with the operating elements require programming. For that, the respective setting buttons are used as follows:



- Press *ESC* to go one step back at a time, readjusted values are not be adopted
- If no setting is made for 8 minutes, the display returns automatically to the basic display
- Operating lines may be hidden, depending on the type of controller, the configuration made and the user level

**Example: “Setting the time of day“** Fehler! Es wurde kein Textmarkenname vergeben.

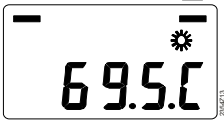
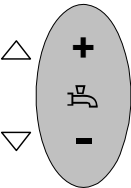
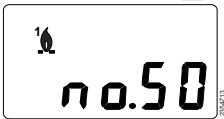
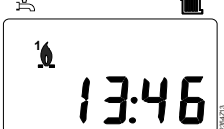
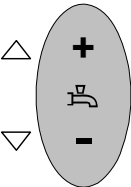
The following example shows how to set the time of day and the date.

Operation	Display example	Description
<p>1</p> 		<p>Basic display. If the basic display does not appear, press the operating mode button.</p> <p>Press OK.</p>
<p>2</p> 	 	<p>The display shows the first operating line, alternating with the value. Press the arrow button until you reach operating line “Hours / minutes” (e.g. 50).</p> <p>Press OK to confirm.</p>
<p>3</p> 		<p>The display shows the hours flashing. Press the "+/-" button until the hours of the time of day are correct.</p> <p>Press OK to confirm.</p>



4

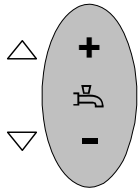

The display shows the minutes flashing.  
Press the "+/-" button until the minutes of the time of day are correct.

Press OK to confirm.

5

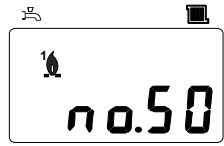

The settings are saved and the displays stops flashing.  
Now, you can make further settings or  
You can press the operating mode button to return to the basic display.

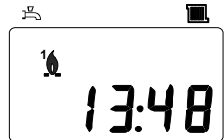

6

Now, you see the basic display again.

## 5.2.2 User levels

The user levels only allow authorized user groups to make settings. To reach the required user level, proceed as follows:

Operation	Display example	Description
1		You see the basic display. Press OK for 3 seconds.
2	 	Now, you are on the user level "End user".  Press INFO for 3 seconds.
3		You are on the user level "Heating engineer". If the change to the "Heating engineer" level was successful, the display shows "ON" as a confirmation.

## 5.2.3 Overview of settings

The table shows all available settings up to the heating engineer level.

Legend

E = end user F = heating engineer

BZ = Operating line

Operating line	Operating line clear-text units	user level	Function	Default value	Min	Max	Unit
<b>Time of day and date</b>							
50	1	E	Hours / minutes	01:00	00:00	23:59	hh:mm
51	2	E	Day/month	1.01	01.01	31.12	dd.mm
52	3	E	Year	2004	2004	2099	yyyy
53	5	F	Start of summertime	25.03	01.01	31.12	dd.mm
54	6	F	End of summertime	25.10	01.01	31.12	dd.mm
59	6220	F	Software version	-	0	99.9	-
<b>Time prog heating circuit 1</b>							
61	500	E	Preselection	Mo-Su			-
62	501	E	1. phase on	6:00	00:00	24:00	hh:mm
63	502	E	1. phase off	22:00	00:00	24:00	hh:mm
64	503	E	2. phase on	--:--	00:00	24:00	hh:mm
65	504	E	2. phase off	--:--	00:00	24:00	hh:mm
66	505	E	3. phase on	--:--	00:00	24:00	hh:mm
67	506	E	3. phase off	--:--	00:00	24:00	hh:mm
<b>Time prog heating circuit 2</b>							
71	520	E	Preselection	Mo-Su			
72	521	E	1. phase on	6:00	00:00	24:00	hh:mm
73	522	E	1. phase off	22:00	00:00	24:00	hh:mm
74	523	E	2. phase on	--:--	00:00	24:00	hh:mm
75	524	E	2. phase off	--:--	00:00	24:00	hh:mm
76	525	E	3. phase on	--:--	00:00	24:00	hh:mm
77	526	E	3. phase off	--:--	00:00	24:00	hh:mm
<b>Heating circuit 1</b>							
81	712	E	Reduced setpoint	16	4	35	°C
82	720	E	Heating curve slope	1.5	0.10	4.00	°C
83	721	F	Heating curve displacement	0	-4.5	4.5	°C
84	730	E	Summer/winter heating limit	18	--- / 8	30	°C
85	741	F	Flow temp setpoint max	80	8	95	°C
<b>Heating circuit 2</b>							
86	1012	E	Reduced setpoint	16	4	35	°C
87	1020	E	Heating curve slope	1.5	0.10	4.00	°C
88	1021	F	Heating curve displacement	0	-4.5	4.5	°C
89	1030	E	Summer/winter heating limit	18	--- / 8	30	°C
90	1041	F	Flow temp setpoint max	80	80	95	°C

## 5.3 QAA55..

### 5.3.1 Operation

#### Operating elements

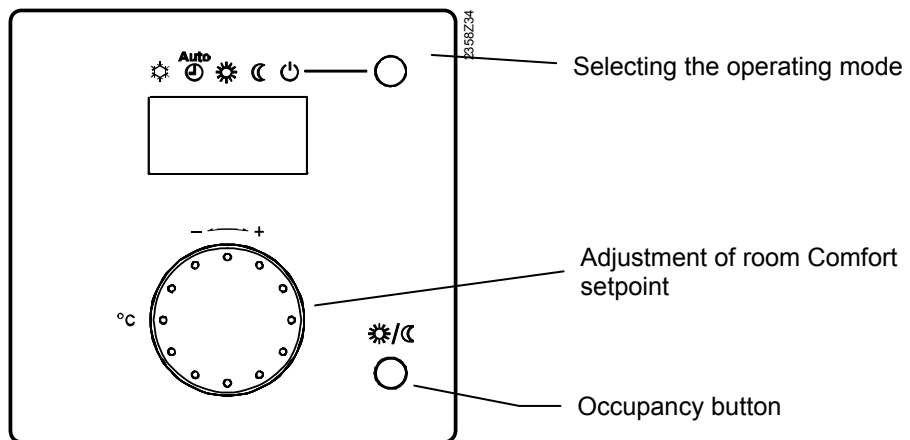

#### Display options

- Heating / cooling to Comfort setpoint
- Heating to Reduced setpoint
- Burner operating (only oil / gas boiler)
- Error messages

#### Display

Display of all displayable symbols and segments.



Example of basic display:



#### Selecting heating mode

This setting is used to switch between the different operating modes. The selection made is indicated by a bar which appears below the respective symbol.

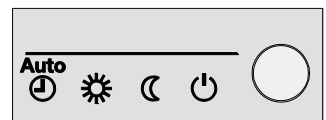

#### Automatic mode

Automatic mode controls the room temperature according to the time program.

Characteristics of automatic mode:

- Heating mode according to the time program
- Temperature setpoints according to the heating program "Comfort setpoint" or "Reduced setpoint"
- Protective functions active
- Automatic summer / winter changeover (ECO functions)

## Continuous operation or

Continuous operation maintains the room temperature at the selected operating level.

 Heating to Comfort setpoint

 Heating to Reduced setpoint

Characteristics of continuous operation:

- Heating mode with no time program
- Protective functions active
- Automatic summer / winter changeover (ECO functions) and 24-hour heating limit inactive in the case of continuous operation with Comfort setpoint

## Protection

When using Protection, the heating system is off. However, it remains protected against frost (frost protection temperature) provided there is no power failure.

Characteristics of Protection:

- Heating off
- Temperature according to frost protection
- Protective functions active
- Automatic summer / winter changeover (ECO functions) and automatic 24-hour heating limit active

## Display cooling mode

(if available)

## Cooling mode

Release of cooling mode is indicated by a bar which appears below the symbol. Cooling mode is active, when the bar for heating operating is hidden. .



Characteristics of cooling mode:

- Cooling mode based on time program
- Temperature setpoint based on "Comfort setpoint, cooling"
- Protective functions active
- Cooling limit by outside temperature

## Adjusting the room temperature setpoint

Either the heating or the cooling setpoint is set depending on the active operating state.

Turn the setting knob to increase or decrease the

**Comfort setpoint**  .

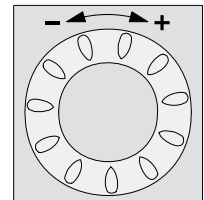

After each readjustment, wait at least 2 hours, allowing the room temperature to adapt.

## Occupancy button

If you do not use the rooms for a longer period of time, you can press the occupancy button to temporarily reduce heating / cooling. When the rooms are occupied again, press again the occupancy button.

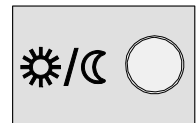

- The occupancy button is only active in automatic operation
- The current selection is active until the next switching action according to the timeswitch program takes place

### 5.3.2 Programming

#### Configuration

A long press (>3 sec) on the occupancy button enables the service level to be accessed. The present value blinks when the parameter is selected. Turn the knob to set the desired value. Select the next setting with a short press of the occupancy button.

#### Settings

Used as

	<i>Display</i>	<i>Function</i>
	ru = 1	Room unit addressed as <b>RG1</b> (default setting)
	ru = 2	Room unit addressed as <b>RG2</b>
	ru = 3	Room unit addressed as <b>RG3</b>
Direct adjustment	P1 = 1	<b>Save automatically:</b> (default setting) A setpoint correction using the knob is assumed by either confirming the operating mode button as without any additional confirmation (timeout) übernommen.
	P1 = 2	<b>Save with confirmation:</b> A setpoint correction using the knob is assumed only after confirming the operating mode button.
Operational lock	P2 = 0	<b>OFF:</b> All operating elements released (default setting)
	P2 = 1	<b>ON:</b> Following operating elements are locked: <ul style="list-style-type: none"> <li>• Operating mode changeover heating circuit</li> <li>• Comfort setpoint adjustment</li> <li>• Operating level changeover (occupancy button)</li> </ul>

**OFF** is displayed for 3 seconds when pressing a locked button when operating lock is active.

The operating lock does not prevent entry to the service level.

## 6 The settings in detail

### 6.1 Time of day and date

The controller has a yearly clock with time of day, weekday and date. To ensure the controller's functionality, both the time of day and the date must be correctly set.

Line no.	Operating line
1	Hours / minutes
2	Day/month
3	Year
5	Start of summertime
6	End of summertime

Summer- / wintertime  
changeover

The dates set for the changeover from wintertime to summertime, and vice versa, ensure that on the first Sunday after the set date the time of day will change from 02:00 (wintertime) to 03:00 (summertime), and from 03:00 (summertime) to 02:00 (wintertime).

### 6.2 Operator section

Operation and display

Line no.	Operating line
20	Language
22	Info Temporarily Permanently
26	Operation lock
27	Programming lock
28	Direct adjustment Automatic storage Save with acknowledgment

Info

Temporarily: After pressing the info button, a change to the "predefined" basic display is made after a maximum of 8 minutes or by pressing the operating mode button (with the QAA78... only 2 minutes).

Continuously: After pressing the info button, a change back to the "new" basic display is made after a maximum of 8 minutes. The info value selected last will be adopted by the new basic display.  
This setting is not possible with the QAA78...

Operation lock

When operation lock is activated, the following operating elements can no longer be adjusted:

Heating circuit operating mode, DHW operating mode, room Comfort setpoint (setting knob), and occupancy button.

Programming lock

When programming lock is activated, parameter values can still be displayed, but can no longer be changed.

- Temporary deactivation of the programming lock.  
Within the programming level, the programming lock can temporarily be overridden. To do this, press the OK and ESC buttons simultaneously for 3 seconds. Temporary deactivation of the programming lock is maintained until programming is quit.
- Constant deactivation of programming lock.  
First, make the temporary deactivation, then go to operating line "Programming lock" (operating line 27) and deactivate the programming lock

## Direct adjustment

### Automatic storage:

A setpoint readjustment with the knob is adopted by pressing the OK button or without any further confirmation (timeout).

### Storage with confirmation:

A setpoint readjustment with the knob is adopted only after pressing the OK button.

## Used as

Line no.	Operating line
40	<b>Used as</b> Room unit 1 Room unit 2 Room unit P Operator unit 1 Operator unit 2 Operator unit P Service unit

This operating line is used to select the use of the operator unit. Depending on use, additional settings will then be required under "Heating circuit assignment". When using several operator units, it is thus possible to match individual units to specific requirements.



- In the case several operator units are used, each application may only be used once.
- The AVS37.294 operator unit is supplied as operator unit 1 (operating line 40) acting on all heating circuits (operating line 42) and can only be readjusted on operating lines 44, 46 and 48

Depending on the selected use of the unit (operating line 40), the following settings (marked with X) can be made when assigning the heating circuit.

Operating line					
40	42	44	46	48	54
Room unit 1	Heating circuit 1				X
	Heating circuits 1 and 2	X		X	X
	Heating circuits 1 and P		X	X	X
	All heating circuits	X	X	X	X
Room unit 2					X
Room unit P					X
Operator unit 1	Heating circuit 1				
	Heating circuits 1 and 2	X		X	
	Heating circuits 1 and P		X	X	
	All heating circuits	X	X	X	
Operator unit 2					
Operator unit P					
Service unit					

### Room unit 1

The operator unit supports the heating circuits released on operating line 42 "Assignment room unit 1" and activated in the basic unit.

### Room unit 2

The operator unit only supports heating circuit 2.

### Operator unit / service unit

The operator unit supports the heating circuits activated in the basic unit.



When using this setting, the operator unit does not acquire and deliver the room temperature.

### Heating circuit assignment

Line no.	Operating line
<b>42</b>	<b>Assignment device 1</b> Heating circuit 1 Heating circuits 1 and 2 Heating circuits 1 and P All heating circuits
<b>44</b>	<b>Operation HC2</b> Commonly with HC1 Independently
<b>46</b>	<b>Operation HCP</b> Commonly with HC1 Independently
<b>48</b>	<b>Action occupancy button</b> None Heating circuit 1 Heating circuit 2 Jointly

#### Assignment device 1

As unit 1 (setting 40), the action of the relevant operator section on heating circuit 1 or on both heating circuits can be assigned. The latter is required especially when using 2 heating circuits and only 1 room unit.

#### Operation HC2

Depending on operating line 40, the action of operation (operating mode button or setting knob) on room unit 1, on the operator unit or service unit can be defined for heating circuit 2.

##### **Commonly with HC1**

Operation acts commonly on heating circuits 1 and 2.

##### **Independently**

The action of operation is queried on the display as soon as the operating mode button is pressed or the setting knob is operated.

#### Operation HCP

Depending on operating line 40, the action of operation (operating mode button or setting knob) on room unit 1, on the operator unit or service unit can be defined for heating circuit P.

##### **Commonly with HC1**

Operation acts commonly on heating circuits 1 and 2.

##### **Independently**

Operating mode changes or readjustments of the Comfort setpoints are to be made in programming mode.

#### Action occupancy button

The action of the occupancy button on the operator unit can be assigned to the relevant heating circuits.

If only 1 heating circuit is assigned, the occupancy button always acts on that heating circuit.

### Room sensor

Line no.	Operating line
<b>54</b>	<b>Readjustment room sensor</b>

The temperature display can be readjusted.

### Device data

Line no.	Operating line
<b>70</b>	<b>Software version</b>

The display shows the current version of the room unit.



## 6.3 Radio

---

### Binding

<i>Line no.</i>	<i>Operating line</i>
<b>120</b>	<b>Binding</b>
<b>121</b>	<b>Test mode</b>

For more detailed information, refer to the descriptions of the wireless components in section 3.8.

### Binding

When commissioning the system, the wireless peripheral devices (room unit) are assigned to the basic unit.

### Test mode

The test mode is used for checking the wireless communication. The test should be made when the installation is fully completed.

### List of wireless devices

<i>Line no.</i>	<i>Operating line</i>
<b>130</b>	<b>Room unit 1</b> Missing Ready No recept'n Change batt
<b>131</b>	<b>Room unit 2</b> Same as on operating line 130
<b>132</b>	<b>Room unit P</b> Same as on operating line 130
<b>133</b>	<b>OutsideSens</b> Same as on operating line 130
<b>134</b>	<b>Repeater</b> Same as on operating line 130
<b>135</b>	<b>Operator unit 1</b> Same as on operating line 130
<b>136</b>	<b>Operator unit 2</b> Same as on operating line 130
<b>137</b>	<b>Operator unit P</b> Same as on operating line 130
<b>138</b>	<b>Service unit</b> Same as on operating line 130
<b>140</b>	<b>Delete all devices</b>

### Delete all devices

The wireless connection to all devices will be cancelled. If radio communication is required again, a new binding must be established.

## 6.4 Time programs

---

For the heating circuits and DHW heating, a number of switching programs are available. They are activated in "Automatic" operation and control the change of the temperature levels (and the associated setpoints) via the selected switching times.

### Entering the switching times

The switching times can be set in a combined way, that is, either commonly for several days or in the form of separate times for individual days. When preselecting groups of days like for instance Mo...Fr and Sa...Su that use the same switching times, setting of the switching programs is simplified.

## Switching points

HC1	HC2	Line no.			Operating line
		3/HCP	4/DHW	5	
<b>500</b>	<b>520</b>	<b>540</b>	<b>560</b>	<b>600</b>	<b>Preselection</b> Mo - Su Mo - Fr Sa - Su Mo - Su
<b>501</b>	<b>521</b>	<b>541</b>	<b>561</b>	<b>601</b>	<b>1. phase on</b>
<b>502</b>	<b>522</b>	<b>542</b>	<b>562</b>	<b>602</b>	<b>1. phase off</b>
<b>503</b>	<b>523</b>	<b>543</b>	<b>563</b>	<b>603</b>	<b>2. phase on</b>
<b>504</b>	<b>524</b>	<b>544</b>	<b>564</b>	<b>604</b>	<b>2. phase off</b>
<b>505</b>	<b>525</b>	<b>545</b>	<b>565</b>	<b>605</b>	<b>3. phase on</b>
<b>506</b>	<b>526</b>	<b>546</b>	<b>566</b>	<b>606</b>	<b>3. phase off</b>

## Standard program

Line no.	Operating line
<b>516, 536, 556, 576, 616</b>	<b>Default values</b>

All time programs can be reset to their default settings. Each time program has its own operating line to make this reset.



In that case, individual settings will be lost!

## 6.5 Holidays

HC1	Line no.		Operating line
	HC2	HCP	
<b>641</b>	<b>651</b>	<b>661</b>	<b>Preselection</b>
<b>642</b>	<b>652</b>	<b>662</b>	<b>Start</b>
<b>643</b>	<b>653</b>	<b>663</b>	<b>End</b>
<b>648</b>	<b>658</b>	<b>668</b>	<b>Operating level</b> Frost protection Reduced

The holiday program is used to switch the heating circuits to a selectable operating level according to calendar dates.



- The holiday program can only be used in "Automatic" mode

## 6.6 Heating circuits

For heating circuits, there are various functions available which can be individually set for each heating circuit.

### Operating mode

Line no.	Operating line
<b>1300</b>	<b>Operating mode</b> Protection mode Automatically Reduced Comfort

The operating mode of heating circuits 1 and 2 is selected directly with the operating mode button while the operating mode of heating circuit P is to be selected in programming mode (operating line 1300).

This setting is used to switch between the different operating modes. The functionality corresponds to operating mode selection with the operating mode button. For details, refer to section "Operation".

## Setpoints

HC1	Line no.		Operating line
	HC2	HCP	
710	1010	1310	Comfort setpoint
712	1012	1312	Reduced setpoint
714	1014	1314	Frost protection setpoint
716	1016	1316	Comfort setpoint maximum

### Room temperature

The room temperature can be shifted according to different setpoints. These setpoints become active depending on the selected operating mode, thus producing different temperature levels in the rooms.

The ranges of adjustable setpoints result from the interdependencies, as this is shown in the following diagram.

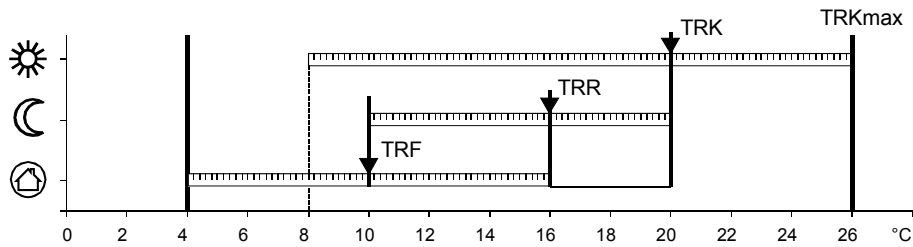

2358Z01

TRKmax Comfort setpoint maximum  
 TRK Comfort cooling setpoint  
 TRR Reduced setpoint  
 TRF Frost protection setpoint

### Frost protection

In Protection mode, the room temperature is prevented from falling below a certain level. This means that the frost protection setpoint of the room temperature will be maintained.

### Comfort setpoint maximum

The room temperature can be shifted according to different setpoints. These setpoints become active depending on the selected operating mode, thus producing different temperature levels in the rooms.

The ranges of adjustable setpoints result from the interdependencies, as this is shown in the following diagram.

## Heating curve

HC1	Line no.		Operating line
	HC2	HCP	
720	1020	1320	Heating curve slope
721	1021	1321	Heating curve displacement
726	1026	1326	Heating curve adaption

The heating curve is used to generate the flow temperature setpoint, which is used to maintain a certain flow temperature level depending on the prevailing weather conditions. The heating curve can be adjusted with a number of settings, thus matching heat output and room temperature to individual needs.

### Heating curve slope

As the heating curve slope is raised, the flow temperature increases the quicker the lower the outside temperature or, in other words, if the room temperature is not correct at low outside temperatures but correct at higher outside temperatures, the heating curve slope requires readjustment.

Increase adjustment: Raises the flow temperature, especially when outside temperatures are low.

Decrease adjustment: Lowers the flow temperature, especially when outside temperatures are low.



The programmed heating curve is based on a room setpoint of 20°C. If the room setpoint is adjusted, the heating curve automatically adapts to the new value.

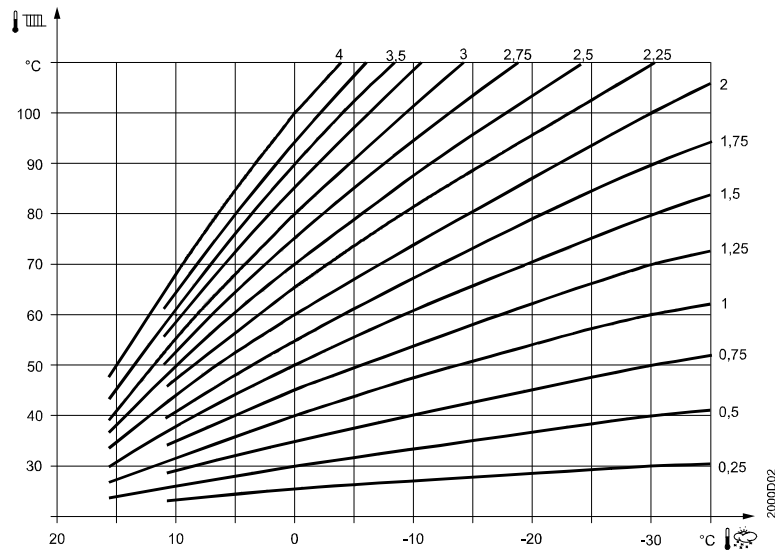

Heating curve displacement

Parallel displacement of the heating curve is used to change the flow temperature evenly across the entire outside temperature range or, in other words, if the room temperature is always too high or too low, a readjustment must be made with the help of the parallel displacement.

Heating curve adaption

Adaptation of the heating curve is used by the controller to automatically adapt the heating curve to the prevailing conditions. In that case, a readjustment of heating curve slope and parallel displacement is not required. It can only be switched on or off.



To assure this function, following must be observed:

- A room sensor must be connected.
- The "Room influence" setting must be selected between 1 and 99
- There should be no thermostatic radiator valves in the reference room (mounting location of room sensor) (If such valves are present, they must be set to their fully open position).

## ECO functions

Line no.			Operating line
HC1	HC2	HCP	
730	1030	1330	Summer/winter heating limit
732	1032	1332	24-hour heating limit

Summer/winter heating limit

The summer / winter heating limit is used to switch the heating on and off in the course of the year, depending on temperature conditions. In Automatic mode, switching on / off takes place automatically, so there is no need for the user to do this manually. By changing the setting, the respective periods of time will be shortened or extended.

Increase: Winter operation will start *earlier*  
Summer operation will start *later*

Decrease: Winter operation will start *later*  
Summer operation will start *earlier*



- The function is not active in operating mode "Continuously Comfort temperature" ☀
- The display shows ECO
- To give consideration to the building's thermal dynamics, the outside temperature will be attenuated

Example:

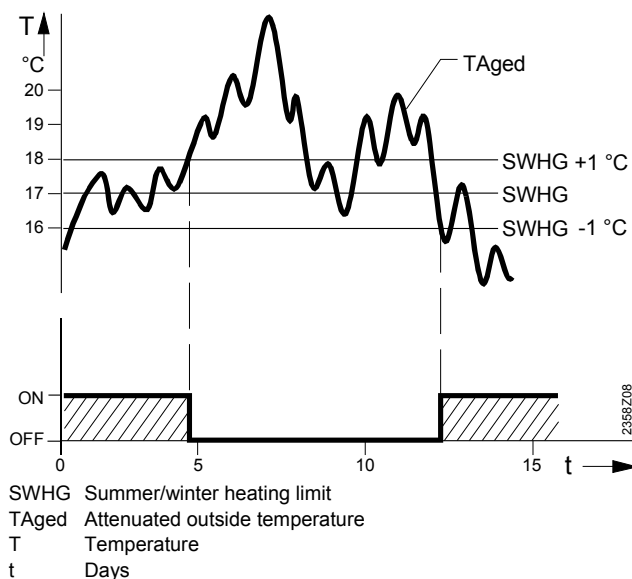

#### 24-hour heating limit

The 24-hour heating limit is used to switch the heating on and off in the course of the day, depending on the outside temperature. This function is used primarily during intermediate seasons (spring and autumn) to respond to short-time temperature variations.

Example:

Setting line	e.g.
Comfort setpoint (TRw)	22°C
24-hour heating limit (THG)	-3°C
Changeover temperature (TRw-THG) heating off	= 19°C
Switching differential (fixed)	-1°C
Changeover temperature heating on	= 18°C

By changing the value entered, the respective heating periods will be shortened or extended.

Increase: Heating mode will start *earlier*,  
changeover to ECO *later*.

Decrease: Heating mode will start *later*,  
changeover to ECO *earlier*.



- The function is not active in operating mode "Continuously Comfort temperature" ☀
- The display shows ECO
- To give consideration to the building's thermal dynamics, the outside temperature will be attenuated

#### Flow temperature setpoint limits

Line no.			Operating line
HC1	HC2	HCP	
<b>740</b>	<b>1040</b>	<b>1340</b>	<b>Flow temp setpoint min</b>

Using this limitation, a temperature range for the flow temperature setpoint can be defined. If the flow temperature setpoint demanded by the heating circuit reaches the relevant limit and the heat request increases or decreases, the flow temperature setpoint will be maintained at the maximum or minimum limit.

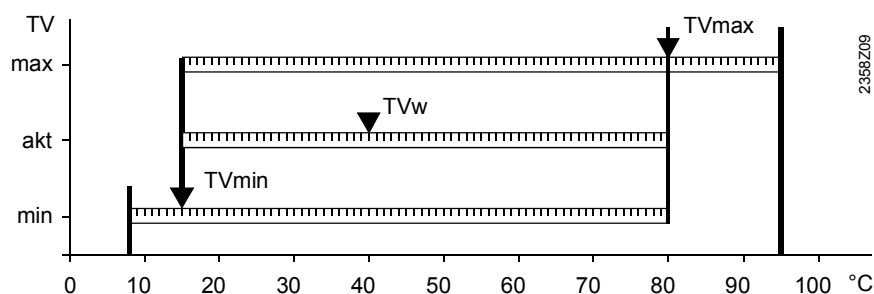

TVw Current flow temperature setpoint  
 TVmax Flow temperature setpoint maximum  
 TVmin Flow temp setpoint minimum

### Room influence

Line no.			Operating line
HC1	HC2	HCP	
<b>750</b>	<b>1050</b>	<b>1350</b>	<b>Room influence</b>

#### Types of compensation:

When a room temperature sensor is used, there is a choice of 3 different types of compensation.

Setting	Type of compensation
— — — %	Pure weather compensation *
1...99 %	Weather compensation with room influence *
100 %	Pure room compensation

\* Outside sensor required.

Weather compensation only

The flow temperature is calculated via the heating curve, depending on the composite outside temperature. This type of compensation calls for a correct adjustment of the heating curve since in that case the control gives **no** consideration to the room temperature.

Weather compensation with room influence

The deviation of the actual room temperature from the setpoint is measured and taken into account when controlling the temperature. Heat gains can thus be considered, facilitating more accurate room temperature control. The effect of the deviation is set as a percentage figure. The better the reference room (correct room temperature, correct mounting location, etc.) the higher the value can be set.

• Example:

Approx. 60 % Good reference room conditions

Approx. 20 % Unfavorable reference room



To activate the function, following must be considered:

- A room sensor must be connected.
- "Room influence" must be set to a value between 1 and 99 %.
- There should be no thermostatic radiator valves in the reference room (mounting location of the room sensor). (If such valves are present, they must be set to their fully open position).

## Room compensation only

The flow temperature is controlled depending on the room temperature setpoint, the current room temperature and the progression of the room temperature. For example, a slight increase of the room temperature causes an immediate drop of the following temperature.



To activate the function, following must be considered:

- A room sensor must be connected.
- "Room influence" must be set to 100 %.
- There should be no thermostatic radiator valves in the reference room (mounting location of the room sensor). (If such valves are present, they must be set to their fully open position).

## Room temp limitation

Line no.			Operating line
HC1	HC2	HCP	
<b>760</b>	<b>1060</b>	<b>1360</b>	<b>Room temp limitation</b>

The "Room temperature limitation" function enables the heating circuit pump to be deactivated should the room temperature exceed the current room temperature setpoint by more than the adjusted differential.

The heating circuit pump will be activated again as soon as the room temperature returns to a level below the current room temperature setpoint.

During the time the "Room temperature limitation" function is active, no request will be sent to the heat source.



Room temperature limitation does not work in the case of pure weather compensation.

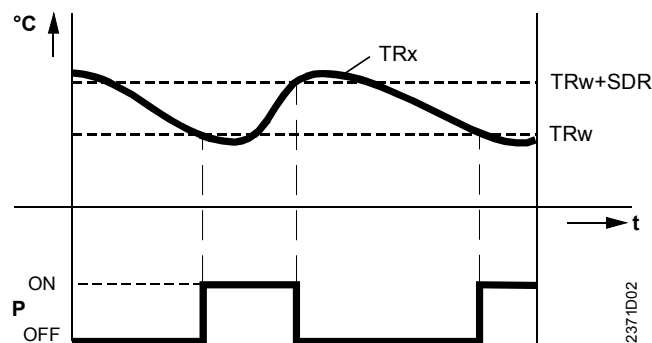

TRx Actual value of room temperature  
 TRw Room temperature setpoint  
 SDR Room switching differential  
 B Pump  
 t Time

## Boost heating

Line no.			Operating line
HC1	HC2	HCP	
<b>770</b>	<b>1070</b>	<b>1370</b>	<b>Boost heating</b>

Boost heating is used to reach the new setpoint more quickly when switching from the Reduced setpoint to the Comfort setpoint, thus reducing the heating up time. During boost heating, the room temperature setpoint is raised by the value set here.

A higher setting leads to shorter heating up times, a lower setting to longer heating up times.



- Boost heating is possible with or without room sensor

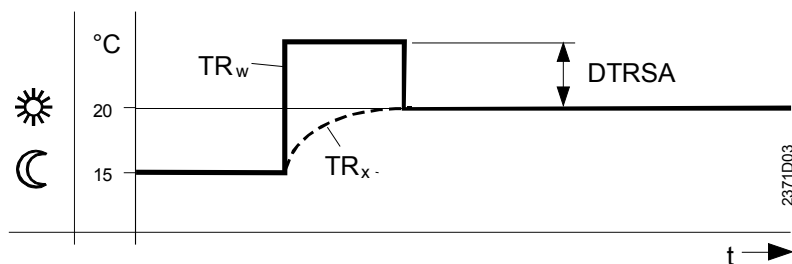

TR<sub>w</sub> The room temperature setpoint  
 TR<sub>x</sub> Actual value of the room temperature  
 DTRSA Increase of room temperature setpoint

### Quick setback

Line no.			Operating line
HC1	HC2	HCP	
<b>780</b>	<b>1080</b>	<b>1380</b>	<b>Quick setback</b> Off Down to reduced setpoint Down to frost prot setpoint

During quick setback, the heating circuit pump is deactivated and, in the case of mixing valve circuits, the mixing valve is fully closed.

- Function with room sensor:  
 When using the room sensor, the function keeps the heating switched off until the room temperature has dropped to the level of the Reduced setpoint or the frost level. When the room temperature has fallen to the Reduced level or the frost level, the heating circuit pump will be activated and the mixing valve will be released.
- Function without room sensor:  
 Quick setback switches the heating off for a certain period of time, depending on the outside temperature and the building time constant.

### Example

Duration of quick setback when Comfort setpoint minus Reduced setpoint = 2°C  
 (e.g. Comfort setpoint = 20°C and Reduced setpoint = 18°C)

Outside air temperature mixed:	Building time constante:						
	0	2	5	10	15	20	50
15 °C	0	3.1	7.7	15.3	23	30.6	76.6
10 °C	0	1.3	3.3	6.7	10	13.4	33.5
5 °C	0	0.9	2.1	4.3	6.4	8.6	21.5
0 °C	0	0.6	1.6	3.2	4.7	6.3	15.8
-5 °C	0	0.5	1.3	2.5	3.8	5.0	12.5
-10 °C	0	0.4	1.0	2.1	3.1	4.1	10.3
-15 °C	0	0.4	0.9	1.8	2.6	3.5	8.8
-20 °C	0	0.3	0.8	1.5	2.3	3.1	7.7
Duration of quick setback in hours							



- Quick setback is possible with or without a room sensor



## Optimum start / stop control

Line no.			Operating line
HC1	HC2	HCP	
<b>790</b>	<b>1090</b>	<b>1390</b>	<b>Optimum start control max</b>
<b>791</b>	<b>1091</b>	<b>1391</b>	<b>Optimum stop control max</b>

Optimum start control max The change from one temperature level to the other is optimized in a way that the Comfort setpoint is reached at the relevant switching time.

Optimum top control max The change from one temperature level to the other is optimized in a way that the Comfort setpoint minus 1/4 °C is reached at the relevant switching time



- Optimum start / stop control is possible with or without room sensor.

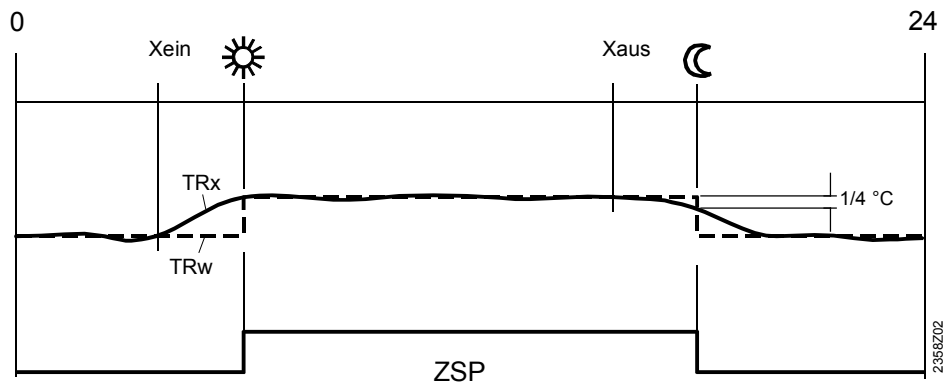

Xein Switch-on time shifted forward in time  
 Xaus Switch-off time shifted forward in time  
 ZSP Time program  
 TRx Actual value of room temperature  
 TRw Room temperature setpoint

## Raising the reduced setpoint

Line no.			Operating line
HC1	HC2	HCP	
<b>800</b>	<b>1100</b>	<b>1400</b>	<b>Red setpoint increase start</b>
<b>801</b>	<b>1101</b>	<b>1401</b>	<b>Red setpoint increase end</b>

The function is used primarily in connection with heating systems with **only** little spare capacity (e.g. low-energy houses). In such cases, the heating up time would be too long at low outside temperatures. When the Reduced setpoint is raised, the rooms are prevented from cooling down to too low levels, thus shortening the heating up time when changing to the Comfort setpoint.

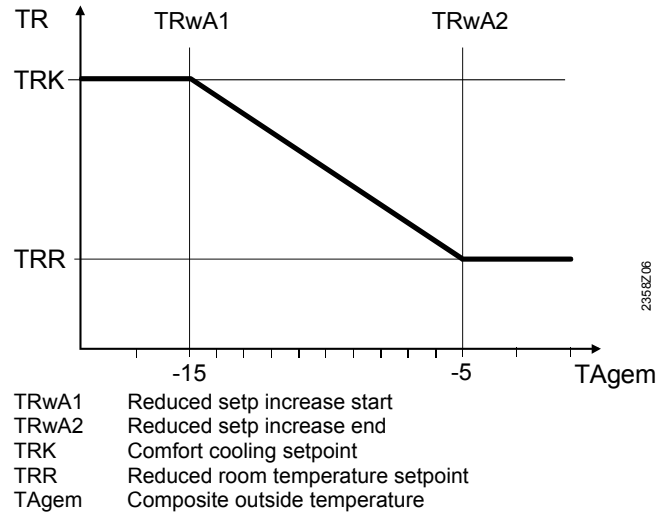

### Overtemp prot pump circuit

Line no.			Operating line
HC1	HC2	HCP	
<b>820</b>	<b>1120</b>	<b>1420</b>	<b>Overtemp prot pump circuit</b>

In the case of heating plant with pump heating circuits, the flow temperature of the heating circuit can be higher than the flow temperature demanded by the heating curve, due to requests from other heat consumers (mixing heating circuit, DHW charging, external heat demand), or a parameterized minimum heat generation temperature. As a result of this too high flow temperature, the pump heating circuit would assume excessive temperatures.

Function "Overtemperature protection for pump heating circuits" ensures that the energy supply for pump heating circuits corresponds to the demand from the heating curve by activating / deactivating the pump.

### Mixing valve control

Line no.		Operating line
HC1	HC2	
<b>830</b>	<b>1130</b>	<b>Mixing valve boost</b>
<b>832</b>	<b>1132</b>	<b>Actuator type</b> 2-position   3-position
<b>833</b>	<b>1133</b>	<b>Switching differential 2-pos</b>
<b>834</b>	<b>1134</b>	<b>Actuator running time</b>

Actuator type

The selection of the type of actuator determines the control behavior for the type of mixing valve actuator used.

Switching differential 2-pos

For the 2-position actuator, the 2-position switching differential must also be adapted. This is not required when using a 3-position actuator.

Mixing valve boost

To ensure proper mixing valve flow temperature control, the flow temperature must be higher than the demanded setpoint of the mixing valve flow temperature. The value set here is added to the request.

Actuator running time

Setting the running time of the actuator used with the mixing valve.

## Floor curing function

Line no.			Operating line
HC1	HC2	HCP	
850	1150	1450	<b>Floor curing function</b> Off Functional heating (Fh) Curing heating (Bh) Functional/curing heating Curing heating/ functional heating Manually
851	1151	1451	<b>Floor curing setp manually</b>
		1455	<b>Floor curing setp current</b>
		1456	<b>Floor curing day current</b>
		1457	<b>Floor curing days complete</b>

The floor curing function ensures controlled drying of the floor. It controls the flow temperature according to a temperature profile. Drying of the floor is ensured via the floor heating system and the mixing or pump heating circuit.

### Floor curing function

#### Off:

Function is deactivated.

#### Functional heating (Fh) :

The first part of the temperature profile is automatically completed.

#### Floor curing heating (Bh)

The second part of the temperature profile is traversed automatically.

#### Functional and floor curing heating

The entire temperature profile (first and second part) is passed automatically.

#### Floor curing heating and functional heating

The entire temperature profile (first and second part) is traversed automatically.

#### Manually

It is not a temperature profile that is completed, but the floor setpoint is controlled manually.



- Observe the relevant standards and regulations of the floor manufacturer!
- Proper functioning is ensured only when the plant is correctly installed (hydraulic system, electrical installation, settings)!  
If not observed, the floor might get damaged!
- The function can be aborted by choosing **Off**.
- Maximum limitation of the flow temperature remains active.

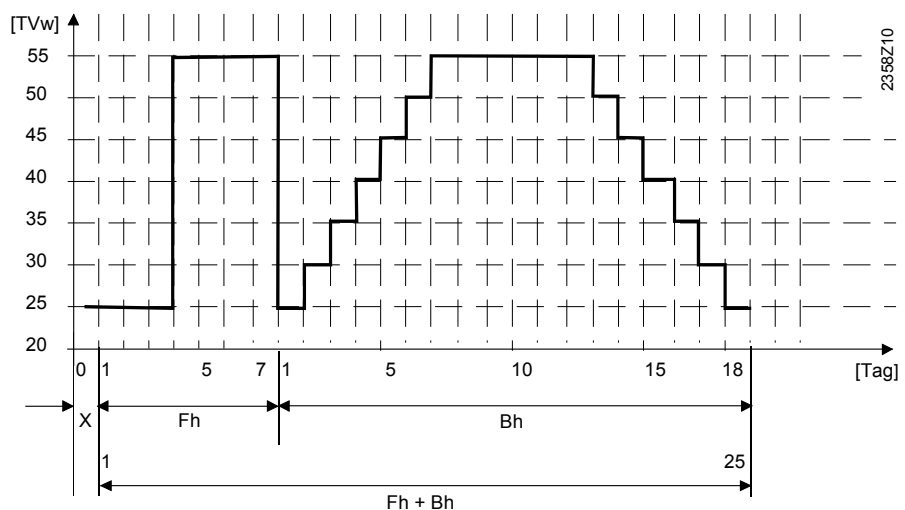

X Start day  
Fh Functional heating  
Bh Floor curing heating

Floor curing setp manual	The flow temperature setpoint for the "Manual" floor-curing function can be set separately for each heating circuit.
Floor curing setp current	Shows the current flow temperature setpoint of the floor-curing process in progress
Floor curing day current	Shows the current day of the floor-curing process in progress.
Floor curing days complete	Displays the number of days the requested flow temperature was met. Fulfilled days are stored when the floor curing function is ended and remained with the function until the next start.

**Excess heat draw**

Line no.			Operating line
HC1	HC2	HC3P	
<b>861</b>	<b>1161</b>	<b>1461</b>	<b>Excess heat draw</b> Off Heating mode Always

Excess heat draw can be triggered by the following functions:

- Inputs H1, H2, H3 or EX2
- Storage tank recooling
- Solid fuel boiler excess heat draw

When dissipation of excess heat is activated, it can be drawn by space heating. This can be adjusted separately for each heating circuit.

**Buffer storage tank / primary controller**

Line no.			Operating line
HC1	HC2	HCP	
<b>870</b>	<b>1170</b>	<b>1470</b>	<b>With buffer storage tank</b>
<b>872</b>	<b>1172</b>	<b>1472</b>	<b>With primary controller / system pump</b>

With buffer storage tank  
If there is a buffer storage tank, specify whether the heating circuit can draw heat from it.  
When using alternative heat sources, the buffer storage tank temperature is used as a control criterion for the release of additional heat sources.

With primary controller / system pump  
Specify whether the heating circuit receives its heat via the primary controller or with the help of the system pump (depending on the type of plant).

**Remote control**

Line no.			Operating line
HC1	HC2	HCP	
<b>900</b>	<b>1200</b>	<b>1500</b>	<b>Optg mode changeover</b> None   Protection   Reduced   Comfort   Automatic

In the case of external changeover via inputs H1 / H2 / H3, the operating mode to be used can be selected.

## 6.7 Cooling circuit

For cooling mode, the operating mode (BZ 901) must be enabled and released by the scheduler (BZ 907). The system automatically operates in cooling mode when the room temperature rises above the Comfort cooling setpoint (operating line 902) and the cooling limit is exceeded.

Cooling mode is interrupted if there is a heating demand from heating/cooling circuit 1, or if a heating demand signal is received from the DHW circuit or another heating circuit.

### Operating mode

Line no.	Operating line
<b>901</b>	<b>Operating mode</b> Off   Automatic

This line is used to set the operating mode for cooling.



This setting is the same as the selection of cooling mode with the cooling button on a room unit.

#### Off

Cooling mode is off.

#### Automatically

Automatic mode controlled by the time program, occupancy button or holiday program, subject to the enable conditions set via operating line 907.



If the cooling enable signal is set to 24h/day via operating line 907, then the cooling button can be used as an on/off button.

### Setpoints

Line no.	Operating line
<b>902</b>	<b>Comfort cooling setpoint</b>

Room setpoint in cooling mode.



Summer compensation, operating line 920 can raise the setpoint as a function of the outside temperature.

### Release

Line no.	Operating line
<b>907</b>	<b>release</b> 24h/day   Time programs HCs   Time program 5

The parameter "Release" determines the time program in accordance with which cooling is enabled.

#### 24 h/day

Cooling is released continuously (24 hours a day)

#### Time programs, HCs

Cooling is enabled in accordance with the heating circuit time program

#### Time program 5

Cooling is enabled in accordance with time program 5.

### Cooling curve

Line no.	Operating line
<b>908</b>	<b>Flow setpoint at OT 25°C</b>
<b>909</b>	<b>Flow setpoint at OT 35°C</b>

Flow temp setpoint

The controller determines the required flow temperature at a specific composite outside temperature. The cooling curve is determined by defining two fixed points (the flow temperature setpoint at 25°C and 35°C).



The programmed cooling curve is based on a room setpoint of 25°C. If the room setpoint is adjusted, the cooling curve automatically adapts to the new value.

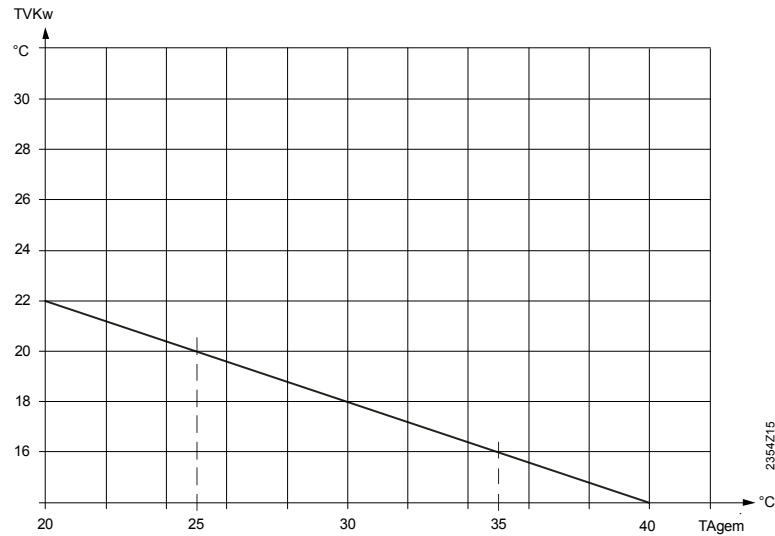

TVKw Flow temperature setpoint, cooling  
TAgem Composite outside temperature

ECO

Line no.	Operating line
<b>912</b>	<b>Cooling limit at OT (outside temperature)</b>
<b>913</b>	<b>Locking period at end of heating</b>

Cooling limit at OT (outside temperature)

If the composite outside temperature rises above the cooling limit temperature, cooling is released; cooling is disabled when the outside temperature drops to at least 0.5°C below the cooling limit temperature.

Locking period at end of heating

To avoid too rapid a change to cooling at the end of the heating phase, the cooling function is disabled for the period which can be set here. This "locking period" begins when there is no heating demand from heating circuit 1.



The locking period is ignored if the cooling function is enabled via the operating mode button.

Summer compensation

Line no.	Operating line
<b>918</b>	<b>Start of summer compensation at OT</b>
<b>919</b>	<b>End of summer compensation at OT</b>
<b>920</b>	<b>Summer compensation setpoint increase</b>

In summer, the cooling comfort setpoint (902) is shifted upwards as the outside temperature increases. This saves cooling energy, and prevents too great a differential between the room and outside air temperature.

Start of summer compensation at OT

Summer compensation starts to take effect at the outside temperature set here. If the outside temperature continues to rise, the comfort setpoint is raised in parallel.

End of summer compensation at OT

Summer compensation takes full effect at this outside temperature (920). The comfort setpoint is not affected by any further increase in the outdoor temperature.

Summer compensation setpoint increase

This setting determines the maximum permissible increase in the comfort setpoint.

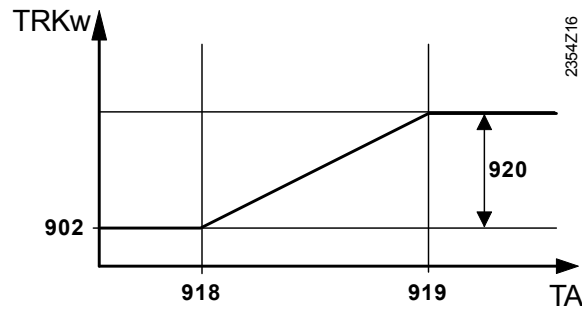

TRKw Cooling setpoint  
TA Outside temperature (OT)

### Flow temperature setpoint limits

Line no.	Operating line
923	Min. flow setpoint at OT 25°C
924	Min. flow setpoint at OT 35°C

A low limit can be defined for the cooling flow temperature. The limit curve is determined by defining two fixed points.

There is also a low limit for the resulting flow setpoint, which must not fall below 5 °C.

Min. flow setpoint

This defines the lowest permissible flow temperature at a composite outside temperature of 25°C/25°C.



If there is no valid outside air temperature available, the controller uses the value "Flow setpoint min TA = 35°C"

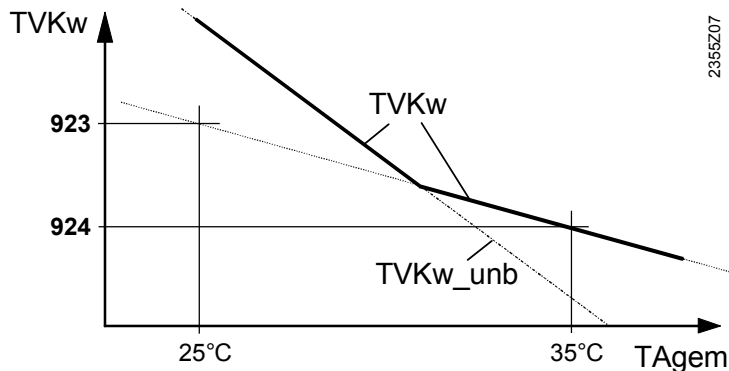

TVKw Flow temperature setpoint for cooling (with low limit control)  
TVKw\_unb Flow temperature setpoint for cooling (without low limit control)  
TAgem Composite outside temperature

### Room influence

Line no.	Operating line
928	Room influence

## Compensation variants

When a room temperature sensor is used, there is a choice of different types of compensation.

Setting	Type of compensation
– – – %	Weather compensation only *
1...99 %	Weather compensation with room influence
100 %	Room compensation only

\* Outside sensor required.

## Weather compensation only

The flow temperature is calculated via the cooling curve as a function of the composite outside temperature.

This type of compensation requires correct adjustment of the heating curve, since in this case, the control does **not** take account of the room temperature.

## Weather compensation with room influence

The deviation of the actual room temperature from the setpoint is measured and taken into account when controlling the temperature. In this way, account is taken of room temperature deviations, to facilitate more accurate room temperature control. The effect of the deviation is set as a percentage figure. The better the reference room (correct room temperature, correct mounting location, etc.) the higher the value can be set.

• Example:

Approx. 60 %    Good reference room conditions

Approx. 20 %    Unfavorable reference room



To activate the function, following must be considered:

- A room sensor must be connected.
- The "Room influence" setting must be selected between 1 and 99
- There should be no controlled valves in the reference room (mounting location of the room sensor) (If such valves are installed, they must be set to their fully open position).

## Room compensation only

The flow temperature is controlled depending on the room temperature setpoint, the current room temperature and the progression of the room temperature. For example, a slight increase of the room temperature causes an immediate drop of the following temperature.



To activate the function, following must be considered:

- A room sensor must be connected.
- "Room influence" must be set to 100 %.
- There should be no controlled valves in the reference room (mounting location of the room sensor) (If such valves are installed, they must be set to their fully open position).

## Room temp limitation

Line no.	Operating line
<b>932</b>	<b>Room temp limitation</b>

The room temperature limitation function makes it possible to disable the cooling circuit pump if the room temperature falls by more than the programmed offset from the effective room setpoint (with summer compensation, operating line 920).

The cooling circuit pump is activated again as soon as the room temperature returns to a level above the current room temperature setpoint.



While the "Room temperature limitation" function is active, no cooling request is sent to the heat source.

The function is deactivated in the following circumstances:

- No room temperature sensor
- "Room temp limitation" = ---
- "Room influence" (928) = --- (weather compensation only)

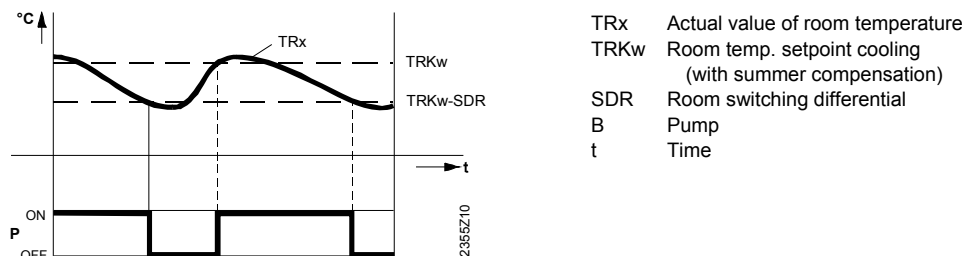

## Mixing valve control

Line no.	Operating line
<b>938</b>	<b>Mixing valve cooling offset</b>
<b>939</b>	<b>Actuator type</b> 2-position   3-position
<b>940</b>	<b>Switching differential 2-pos</b>
<b>941</b>	<b>Actuator running time</b>
<b>945</b>	<b>Mixing valve in heating mode</b> Control   Open

### Mixing valve cooling offset

The refrigeration demand from the mixing valve circuit to the heat source is reduced by the programmed value. The purpose of this reduction is to enable the mixing valve controller to compensate for the fluctuation in temperature caused by the heat source (2-point control action).

### Actuator type

#### 2-position

The controller drives the actuator with only 1 relay output. When the output delivers a signal, the valve opens. When there is no signal, the valve will close automatically.

#### 3-position

The controller drives the actuator with 2 relay outputs. 1 of the outputs is used for opening the valve and 1 for closing the valve.

### Switching differential 2-pos

For the 2-position actuator, the "2-position switching differential" must also be adapted. Three-position actuators are not affected by the switching differential.

### Actuator running time

For the 3-position actuator, the running time of the mixing valve actuator can be adjusted. The actuator running time has no effect on two-position actuators.

### Mixing valve in heating mode

Defines the position of the mixing valve (Y1/Y2) when heating mode is active. This parameter has no effect in systems with hydraulically separate heating and cooling circuits.

#### Controls

The valve is used for control in heating and cooling mode.

#### Open

The valve is used for control in cooling mode and is open in heating mode.

## Dewpoint monitoring

Line no.	Operating line
946	Dewpt monitor locking time
947	Flow setpt increase hygro
948	Start flow increase at R.H.
950	Flow temp diff dewpoint

Dewpt monitor locking time



When the connected dewpoint monitor detects the **formation of condensation** it closes the contact, thereby **deactivating the cooling**.

The "dewpoint monitor locking time" set here starts running as soon as the contact re-opens. Cooling can only start after expiry of this locking time.

The dewpoint monitor must be assigned to the H.. input as "dewpoint monitor".

Flow setpt increase hygro



To prevent the formation of condensation due to excess indoor air humidity, a hygrostat can be used to implement a **fixed increase in the flow temperature**.

As soon as the air humidity rises above the value set on the hygrostat, the contact is closed and the flow temperature setpoint is increased by the amount programmed here.

The hygrostat must be assigned to the H.. input as "Flow setpt increase hygro".

Start flow increase at R.H.



To prevent the formation of condensation due to excess indoor air humidity, a 0...10 V humidity measurement can be used to implement a **proportional increase in the flow temperature**.

If the relative humidity in the room exceeds the value defined by "Start flow increase at R.H." the flow temperature setpoint is increased proportionally. The start of the increase (BZ 948) and the maximum increase (BZ 947) can be programmed.

The humidity sensor must be assigned to the H.. input as "Relative room humidity 10V".

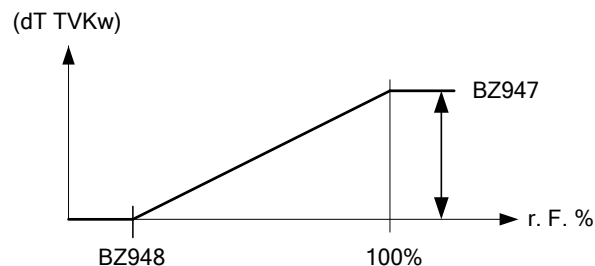

dT TVKw Flow setpoint increase  
r.h. Relative humidity  
BZ Operating line

Flow temp diff dewpoint



The dewpoint temperature is determined on the basis of the relative humidity of the indoor air and the associated room air temperature.

To prevent the formation of condensation on surfaces, a minimum limit is applied to the flow temperature so that it remains above the dew point temperature by the value set here (operating line 950).

The function can be disabled with the setting ---.

The humidity sensor must be assigned to an H.. input as "Relative room humidity 10V", and a room temperature sensor must also be available (assigned to the H.. input as "Room temperature 10V" or room unit).

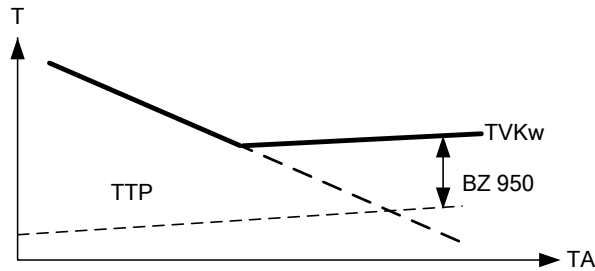

TVKw Flow temperature setpoint, cooling  
TTP Dew point temperature  
TA Outside temperature (OT)  
BZ Operating line

### Buffer storage tank / primary controller

Line no.	Operating line
<b>962</b>	<b>With buffer storage tank</b> No   Yes
<b>963</b>	<b>With primary controller / system pump</b> No   Yes

With buffer storage tank

If there is a buffer storage tank, this setting defines whether the cooling circuit can draw cooling energy from it.

With primary controller / system pump

This determines whether the cooling circuit is supplied via the primary controller or with the help of the system pump (depending on the type of plant).

### Remote control

Line no.	Operating line
<b>969</b>	<b>Optg mode changeover</b> None   Off   Automatic

In the case of external changeover via inputs H1 / H2 / H3, the operating mode to be used can be selected.

## 6.8 DHW



For the RVS46.530, DHW settings are only displayed when using a BMU (Boiler Management Unit) with the appropriate functionality.

### Setpoints

Line no.	Operating line
<b>1610</b>	<b>Nominal setpoint</b>
<b>1612</b>	<b>Reduced setpoint</b>

The DHW can be heated up according to different setpoints. These setpoints are activated depending on the selected operating mode, thus leading to different temperature levels in the DHW storage tank.

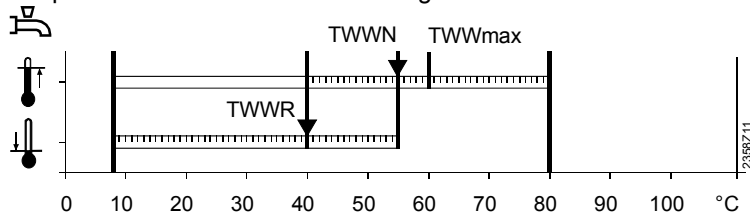

TWWR DHW reduced setpoint  
TWWN DHW nominal setpoint  
TWWmax DHW nominal setpoint maximum

## Release

Line no.	Operating line
<b>1620</b>	<b>release</b> 24 h/day Time programs HCs Time program 4/DHW

### 24 h/day

The DHW temperature is constantly maintained at the nominal DHW setpoint, independent of any time programs.

Example:

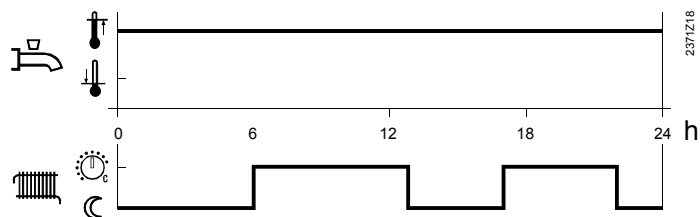

### Time programs HCs

The DHW setpoint is switched between the nominal DHW setpoint and the reduced DHW setpoint according to the heating circuits' time programs. The first switch-on point of each period is shifted forward in time by one hour.

Example:

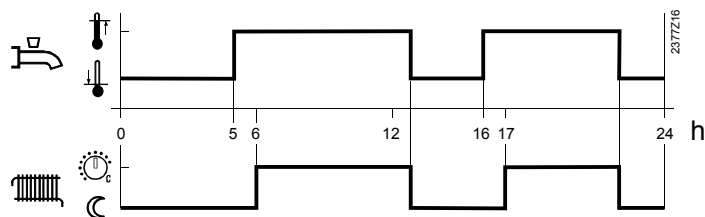

### Time program 4/DHW

For DHW heating, time program 4 of the local controller is taken into consideration. The set switching times of that program are used to switch between the nominal DHW setpoint and the reduced DHW setpoint. This way, the DHW is heated independently of the heating circuits.

## Priority

Line no.	Operating line
<b>1630</b>	<b>Charging priority</b> Absolute Shifting None MC shifting, PC absolute

When both space heating and DHW demand heat, the "DHW priority" function ensures that during DHW charging the heat generation capacity is used primarily for DHW.

### Absolute priority

The mixing and pump heating circuit stay locked until DHW heating is finished.

### Shifting priority

If the capacity of the heat source is not sufficient, the mixing and pump heating circuit will be restricted until DHW is heated up.

### No priority

DHW heating and space heating take place at the same time.

In the case of tightly sized heat generators and mixing heating circuits, it can occur that the DHW setpoint will not be reached if space heating calls for considerable amounts of heat.

### Mixing heating circuit shifting, pump heating circuit absolute

The pump heating circuits stay locked until the DHW storage tank is heated up. If the capacity of the heat source is not sufficient, the mixing heating circuits will also be restricted.

## Legionella function

Line no.	Operating line
<b>1640</b>	<b>Legionella function</b> Off Periodically Fixed weekday
<b>1641</b>	<b>Legionella funct periodically</b>
<b>1642</b>	<b>Legionella funct weekday</b> Monday...Sunday
<b>1644</b>	<b>Legionella funct time</b>
<b>1645</b>	<b>Legionella funct setpoint</b>
<b>1646</b>	<b>Legionella funct duration</b>
<b>1647</b>	<b>Legionella funct circ pump</b>

RVS46.543 only

### Legionella function

- Periodically

The legionella function is repeated according to the period of time set (operating line 1641). The legionella setpoint is attained via a solar plant, independent of the period of time set, the period of time will be newly started.

- Fixed weekday

The legionella function can be activated on a fixed weekday (operating line 1642). When using this setting, heating up to the legionella setpoint takes place on the selected weekday, independent of previous storage tank temperatures.

### Legionella funct circ pump

During the time the legionella function is carried out, the DHW circulating pump can be activated.



During the time the legionella function is carried out, there is a risk of scalding when opening the taps.

## Circulating pump

RVS46.543 only

Line no.	Operating line
<b>1660</b>	<b>Circulating pump release</b> Time program 3/HCP DHW release Time program 4/DHW Time program 5
<b>1661</b>	<b>Circulating pump cycling</b>
<b>1663</b>	<b>Circulation setpoint</b>

RVS46.543 only

RVS46.543 only

### Circulating pump cycling

When the function is activated, the circulating pump is switched on for 10 minutes within the release time and then switched off again for 20 minutes.

### Circulation setpoint

If a sensor is installed in the DHW distribution pipe, the controller will monitor its actual value during the time the legionella function is performed. The adjusted setpoint must be maintained at the sensor during the adjusted "Dwelling time".

## 6.9 Hx pumps

### Hx pumps

<i>Line no.</i>	<i>Operating line</i>
<b>2010</b>	<b>H1 Excess heat draw</b>
<b>2012</b>	<b>H1 with storage buffer tank</b>
<b>2014</b>	<b>H1 prim contr/system pump</b>
<b>2015</b>	<b>H1 Refrig demand</b> 2-pipe system 4-pipe system
<b>2035</b>	<b>H2 Excess heat draw</b>
<b>2037</b>	<b>H2 with buffer storage tank</b>
<b>2039</b>	<b>H2 prim contr/system pump</b>
<b>2040</b>	<b>H2 Refrig demand</b> 2-pipe system 4-pipe system

#### Excess heat draw

Excess heat draw can be triggered by the following functions:

- Input H1, H2 or EX2
- Storage tank recooling
- Solid fuel boiler excess heat draw

When dissipation of excess heat is activated, it can be drawn by space heating. This can be adjusted separately for each heating circuit.

#### With buffer storage tank

If there is a buffer storage tank, this defines whether the H1/H2/H3 circuit can draw heat from it.

When using alternative heat sources, the buffer storage tank temperature is used as a control criterion for the release of additional heat sources.

#### With primary controller / system pump

This defines whether the H1/H2/H3 circuit receives its heat via the primary controller or with the help of the system pump (depending on the type of plant).

#### Refrigeration demand

##### **2-pipe system**

The cooling circuit with Hx and the heating circuits demand cooling/heating from the same primary circuit.

##### **4-pipe system**

The cooling circuit with Hx and the heating circuits demand cooling/heating from separate primary circuits.

## 6.10 Primary controller / system pump

### Primary controller / system pump

<i>Line no.</i>	<i>Operating line</i>
<b>2150</b>	<b>Primary controller / system pump</b> Before buffer st tank After buffer st tank

If the plant uses a buffer storage tank, it is to be set here whether, hydraulically, the primary controller or the system pump is installed upstream from the buffer storage tank.

## 6.11 Solar

### Charging controller (dT)

Line no.	Operating line
<b>3810</b>	<b>Temp diff on</b>
<b>3811</b>	<b>Temp diff off</b>
<b>3812</b>	<b>Charg temp min DHW st tank</b>

For charging the storage tank via the heat exchanger, the temperature differential between collector and storage tank / swimming pool must be sufficient, and the collector must have reached the minimum charging temperature for the storage tank / swimming pool.

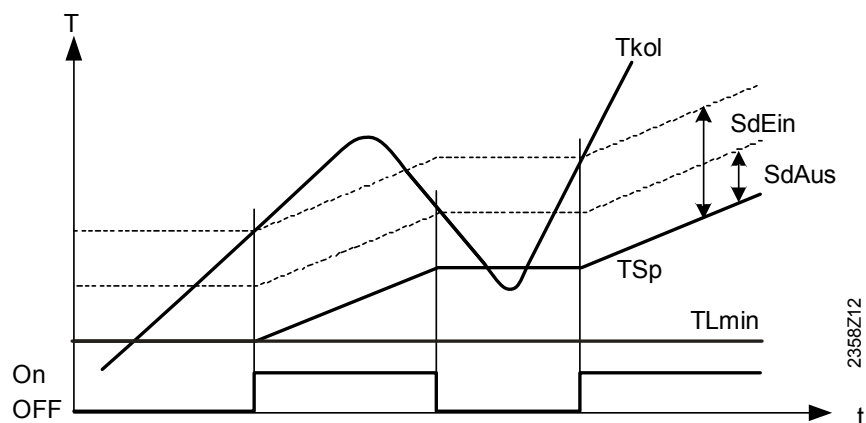

Tkol	Collector temperature
On / Off	Collector pump
SdOn	Temperature differential ON
SdOff	Temperature differential OFF
TSp	Storage tank temperature
TLmin	Charging temp min DHW storage tank / buffer / swimming pool

### Start function

Line no.	Operating line
<b>3831</b>	<b>Min run time collector pump</b>
<b>3834</b>	<b>Collector start funct gradient</b>

Min run time collector pump

The function periodically activates the collector pump for at least the selected minimum running time.

Collector start funct gradient

When the temperature at the collector sensor rises, the collector pump is activated.

### Frost protection for the collector

Line no.	Operating line
<b>3840</b>	<b>Collector frost protection</b>

When there is risk of frost at the collector, the collector pump will be activated to prevent the heat-carrying medium from freezing.

- If the collector temperature falls below the frost protection temperature, the collector pump will be activated:  $TKol < TKolFrost$ .
- When the collector temperature returns to a level of  $1^{\circ}K$  above the frost protection temperature, the collector pump will be deactivated again:  $TKol > TKolFrost + 1$ .

## Overtemperature protection for the collector

Line no.	Operating line
<b>3850</b>	<b>Collector overtemp prot</b>

If there is a risk of overtemperature at the collector, storage tank charging is continued to reduce the amount of surplus heat. When the storage tank safety temperature is reached, charging will be stopped.

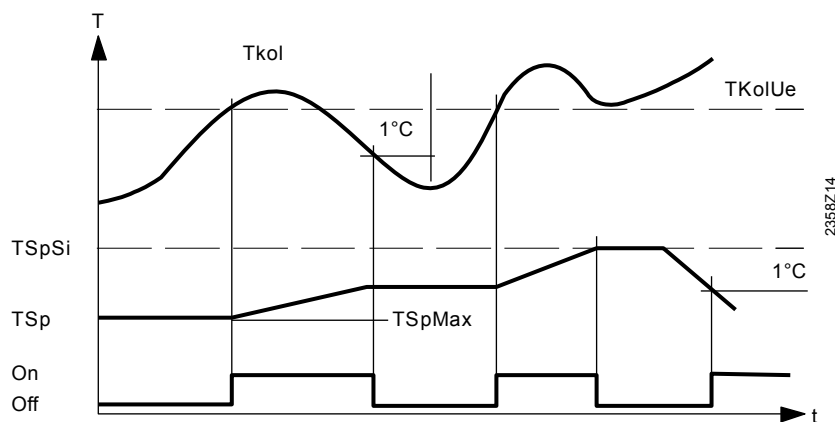

TSpSi	Storage tank safety temperature
TSp	Storage tank temperature
TKolUe	Collector temperature for overtemperature protection
TSpmax	Maximum charging temperature
Tkol	Collector temperature
On / Off	Collector pump
T	Temperature
t	Time

## Medium's evaporation temperature

Line no.	Operating line
<b>3860</b>	<b>Evaporation heat carrier</b>

If there is a risk of the heat carrying medium evaporating due to high collector temperatures, the collector pump will be deactivated to prevent it from reaching excessive temperatures. This is a protective pump function.

Pump speed  
Minimum/maximum  
**Yield measurement**

The solar pump motor speed is limited by a minimum and maximum permitted speed.

Line no.	Operating line
<b>3880</b>	<b>Antifreeze</b>
<b>3881</b>	<b>Antifreeze concentration</b>
<b>3884</b>	<b>Pump capacity</b>

The 24-hour and total solar energy yield (operating lines 8526 and 8527) is calculated, based on these data.

Antifreeze

Since the mixing ratio of the collector medium has an impact on heat transmission, the type of antifreeze used and its concentration must be entered in order to be able to determine the energy yield.

Pump capacity

The flow rate in l/h of the pump used must be determined and serves for calculating the volume delivered.



## 6.12 DHW storage tank

### Charging control

Line no.	Operating line
<b>5020</b>	<b>Flow setpoint boost</b>
<b>5021</b>	<b>Transfer boost</b>
<b>5022</b>	<b>Type of charging</b> With B3 With B3 and B31 With B3, legio B3 and B31

**Flow setpoint boost** The DHW request to the heat generator is made up of the current DHW setpoint plus the adjustable charging increase.

**Increase of transfer boost** Heat transfer makes it possible to transport energy from the buffer storage tank to the DHW storage tank. In that case, the actual buffer storage tank temperature must be higher than the actual temperature of the DHW storage tank. The temperature differential can be set here.

**Type of charging** The storage tank can be charged using up to 2 sensors. It is also possible to combine partial charging with 1 sensor and the legionella function with 2 sensors (setting 3).

### Overtemperature protection

Line no.	Operating line
<b>5050</b>	<b>Charging temperature max</b>

Solar energy charges the DHW storage tank up to the adjusted maximum DHW charging level.



The protective collector overtemperature function can reactivate the collector pump until the maximum storage tank temperature is reached.

### Recooling

Line no.	Operating line
<b>5055</b>	<b>Recooling temperature</b>
<b>5056</b>	<b>Recooling boiler/HC</b>
<b>5057</b>	<b>Recooling collector</b> Off Summer Always

- Recooling heat gen/HCs** For recooling the DHW storage tank, there are 2 functions available:
- Heating energy can be drawn off either by space heating or the DHW storage tank. This can be selected separately for each heating circuit (operating page heating circuit 1...).
- Recooling collector**
- If the collector is cold, the energy can be emitted to the environment via the collector's surfaces.

## Electric immersion heater

Line no.	Operating line
<b>5060</b>	<b>EI imm heater optg mode</b> Substitute Summer Always
<b>5061</b>	<b>EI immersion heater release</b> 24 h/day DHW release Time program 4/DHW
<b>5062</b>	<b>EI immersion heater control</b> External thermostat DHW sensor

electric immersion  
heater:operating mode

### Substitute

The electric immersion heater is only used if the heat generation delivers a fault status message or if it has been shut down via heat generation lock. This means that in normal situations the DHW is always heated by the heat generation.

### Summer

The electric immersion heater is used as soon as all connected heating circuits have switched to summer operation. The DHW is again heated by heat generation as soon as at least one of the heating circuits has switched back to heating operation. The electric immersion heater is also used if the heat generation delivers a fault status message or if it has been shut down via heat generation lock.

### Always

DHW is heated with the electric immersion heater throughout the year. This means that with this application, heat generation never required for DHW heating.

Electric immersion heater  
release

### 24 h/day

The electric immersion heater is always released, independent of time programs.

Example:

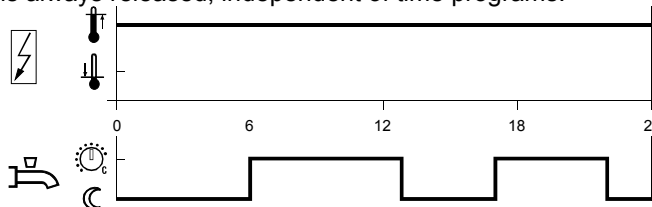

### DHW release

The electric immersion heater is switched on and off according to DHW release.

Example:

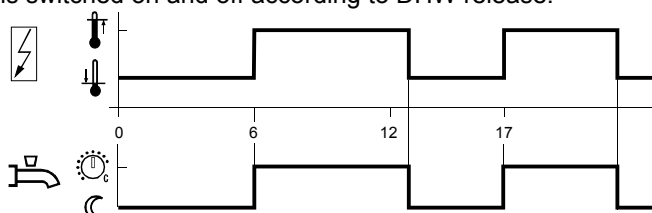

### Time program 4/DHW

For the electric immersion heater, time program 4 / DHW of the local controller is taken into account.

Example:

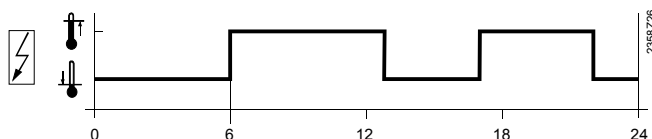

El immersion heater control

### External thermostat

The storage tank is charged with an external thermostat without setpoint compensation of the controller.

### DHW sensor

The storage tank is charged with an electric immersion heater, with setpoint compensation from the controller.



To ensure that setpoint compensation operates as required, the external control thermostat must be set to the minimum storage temperature.

### Excess heat draw

Line no.	Operating line
<b>5085</b>	<b>Excess heat draw</b> Off On

Excess heat draw

Excess heat draw can be triggered by the following functions:

- Inputs H1, H2, H3 or EX2
- Storage tank recooling
- Solid fuel boiler excess heat draw

When dissipation of excess heat is activated, it can be drawn by space heating. This can be adjusted separately for each heating circuit.

### Plant hydraulics

Line no.	Operating line
<b>5090</b>	<b>With buffer storage tank</b>
<b>5092</b>	<b>With prim contr/system pump</b>
<b>5093</b>	<b>With solar integration</b>

With buffer storage tank

If there is a buffer storage tank, specify whether the DHW storage tank can draw heat from it.

When using alternative heat sources, the buffer storage tank temperature is used as a control criterion for the release of additional heat sources.

With primary controller / system pump

It is to be set whether the DHW storage tank receives its heat via the primary controller or with the help of the system pump (depending on the type of plant).

With solar integration

It is to be set whether the DHW storage tank receives its heat from the solar collectors.

RVS46.543 only

## 6.13 Instantaneous DHW heater

---

### Mixing valve control

Line no.	Operating line
<b>5544</b>	<b>Actuator running time</b>

Actuator running time

Setting the running time of the actuator used with the mixing valve.

## 6.14 Configuration

### Heating circuits

Line no.		Operating line	
HC1	HC2		
5710	5715		Heating circuit 1, 2

Using this setting, the heating circuits can be switched on and off.

Line no.	Operating line
5711	Cooling circuit 1 Off 4-pipe system 2-pipe system
5712	Use of mixing valve 1 Heating Cooling Heating and cooling

### Cooling circuit 1

#### Off

The cooling circuit is deactivated.

#### 4-pipe system

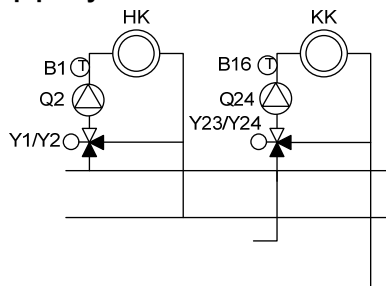

The cooling and heating circuits draw their cooling/heating energy from separate primary circuits.

#### 2-pipe system

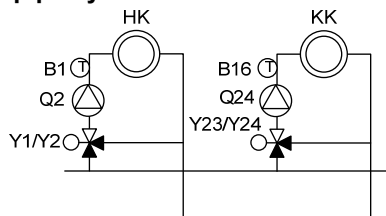

The cooling and heating circuits draw their cooling/heating energy from the same primary circuit.

### Use of mixing valve 1

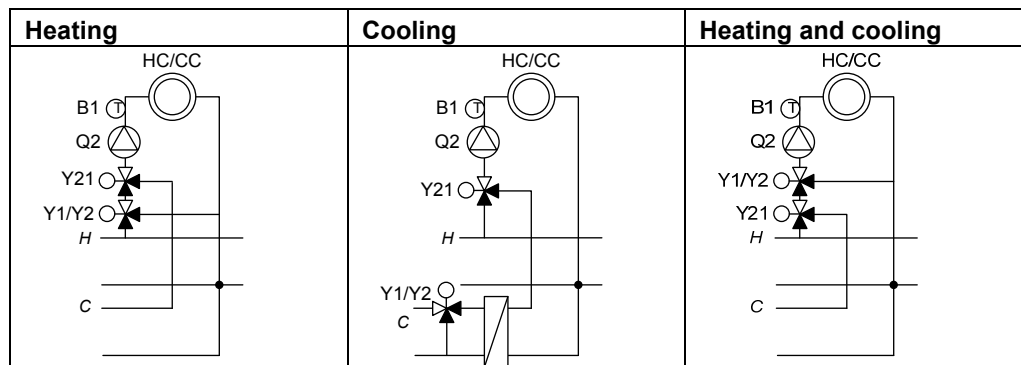

The setting is required when a QX... relay output (configuration) is used as a diverting cooling valve Y21.

## DHW sensor B3

RVS46.543 only

Line no.	Operating line
5730	<b>DHW sensor B3</b> Sensors Thermostat

### Sensors

The collector calculates the switching points including the switching differential from the DHW setpoint and the acquired DHW storage tank temperature.

### Control thermostat

The DHW temperature is controlled based on the switching state of a thermostat connected to B3.



When using a DHW thermostat, Reduced mode is not possible. This means that when Reduced mode is active, DHW heating with the thermostat is locked.



- The adjustment of the nominal DHW temperature setpoint must be equal to or higher than the setpoint adjustment on the thermostat (thermostat calibrated at switch-off point)
- The flow temperature setpoint for DHW must be set to a minimum of 10 °C (has an impact on the charging time).
- In that case, the DHW is not protected against frost.

## DHW control element Q3

RVS46.543 only

Line no.	Operating line
5731	<b>DHW actuating device Q3</b> None Charging pump Diverting valve

### None

No DHW charging via Q3.

### Charging pump

The DHW is charged with a pump connected to terminal Q3/Y3.

### Diverting valve

The DHW is charged with a diverting valve connected to terminals Q3/Y3. With this setting, pump Q2 becomes a heat generation pump, provided the heat generation pump is not yet defined for use at a multifunctional relay output QX...

## Output relay QX

RVS46.543 only

Line no.	Operating line
5890	<b>Relay output QX1</b> None Circulating pump Q4 EI imm heater DHW K6 Collector pump Q5 H1 pump Q15 Alarm output K10 2nd pump speed HC1 Q21 2nd pump speed HC2 Q22 2nd pump speed HCP Q23 Heat circ pump HCP Q20 H2 pump Q18 System pump Q14 Time program 5 K13 DHW mixing pump Q35 DHW interm circ pump Q33 Heat request K27 Refrig demand K28 Dehumidifier K29 Diverting valve, cooling Y21

Depending on the selection made, setting the relay outputs assigns appropriate extra functions to the basic diagrams. For detailed information, refer to section "Application diagrams".

#### DHW circulating pump Q4

The connected pump serves as a DHW circulating pump.

Operation of the pump can be scheduled as required on operating page "DHW", operating line "Release circulating pump".

#### DHW electric immersion heater K6

Using the connected electric immersion heater, the DHW can be heated up according to operating page "DHW storage tank", operating line "Electric immersion heater".



The electric immersion heater must be fitted with a safety limit thermostat!



Operating line 5060 of the electric immersion heater's operating mode must be appropriately set.

#### Collector pump Q5

When using a solar collector, a circulating pump for the collector circuit is required.

#### Pump H1 Q15

Pump H1 can be used for an additional consumer. Together with an external request for heat at input H1, it is possible to operate an air heater or similar.

#### Alarm output K10

The alarm relay signals faults, should they occur.

Switching on takes place with a delay of 2 minutes.

When the fault is corrected, that is, when the error message is no longer present, the relay will be deenergized with no delay.



If the fault cannot immediately be corrected, it is still possible to reset the alarm relay. This is made on operating page "Faults".

#### 2nd pump speed

This function facilitates the control of a 2-speed heating circuit pump, allowing the pump's capacity to be lowered in Reduced mode (e.g. during night setback). In that case, multifunctional relay QX is used to activate the 2nd pump speed in the following manner:

1st speed output Q2/Q6/Q20	2nd speed Output Q21/Q22/Q23	Pump state
Off	Off	Off
On	Off	Part load
On	On	Full load

#### Heating circuit pump HCP Q20

Pump heating circuit P will be activated.

- Time program

For heating circuit P, only time program 3/HCP is available. For more detailed information, refer to section "Time program".

### H2 pump Q18

Pump H2 can be used for an additional consumer. Together with an external demand for heat at input H2, it is possible to serve an air heater or similar.

### System pump Q14

The connected pump serves as a system pump for supplying heat to other consumers. The system pump is put into operation as soon as one of consumers calls for heat. If there is no demand for heat, the pump will be deactivated followed by overrun.

### Time program 5 K13

The relay is controlled according to the settings made in time program 5.

### DHW mixing pump Q35

Separate pump for storage tank circulation during the time the legionella function is active.

### DHW interm circ pump Q33

Charging pump with DHW storage tank using an external heat exchanger.

### Heat request K27

As soon as there is demand for heat, output K27 is activated.

### Refrig demand K28

As soon as there is refrigeration demand, output K28 is activated.

In the case of the device with address 1, a refrigeration demand from the system can activate output K28. For this purpose, operating line 6627 "Refrig demand K28" on the operating page "LPB system" must be set to "Centrally".

### Dehumidifier K29

An external dehumidifier can be enabled if the indoor air humidity rises. In this case, a humidity sensor must be connected to the H... input.

The function of the dehumidifier depends on the cooling functions.

The operation of the dehumidifier is not affected by operating modes, holiday programs, occupancy buttons etc.

### Diverting valve, cooling Y21

With common distribution to the heating and cooling circuits, the inputs/outputs are always on the mixing valve group on the basic unit. For a 4-pipe system, diverting valve Y21 is also required.

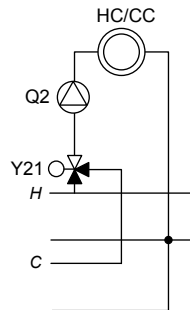

Example:  
Draw off via 4-pipe system

### Input sensor BX

RVS46.543 only

Line no.	Operating line
<b>5930,5931</b>	<b>Sensor input BX1, 2, 3, 4</b> None DHW sensor B31 Collector sensor B6 DHW circulation sensor B39

	DHW charging sensor B36 Solar flow sensor B63 Solar return sensor B64
--	---

Depending on the selection made, setting of the sensor input assigns appropriate extra functions to the basic diagrams. For detailed information, refer to section “Application diagrams”.

## Input H1

Line no.	Operating line
<b>5950</b>	<b>Function input H1</b> Optg mode changeover HCs+DHW Optg mode changeover HCs Optg mode changeover HC1 Optg mode changeover HC2 Optg mode changeover HCP Error/alarm message Min flow temp setpoint Excess heat discharge Dew point monitor Flow setpt increase hygro Refrigeration demand Heat request 10V Refrig demand 10V Pressure measurement 10V Relative room humidity 10V Room temperature 10V
<b>5951</b>	<b>Contact type input H1</b> NC N/O
<b>5952</b>	<b>Function value, contact type H1</b>
<b>5953</b>	<b>Voltage value 1, H1</b>
<b>5954</b>	<b>Function value 1, H1</b>
<b>5955</b>	<b>Voltage value 2, H1</b>
<b>5956</b>	<b>Function value 2, H1</b>

### Function of input H1

#### Changeover of operating mode

- Heating circuit

The operating modes of the heating circuits are switched to Protection mode via the H... terminals (e.g. using a remote telephone switch).

- DHW

DHW heating is locked only when using setting 1: HCs+DHW.

#### Heat generation lock

The heat source is locked via the H... terminals.

All temperature requests made by the heating circuits and by DHW will be ignored.

Frost protection is maintained.



The chimney sweep function can be activated although the heat generation lock is switched on.

#### Error/alarm message

Input H1 generates a controller-internal error message.

If the “Alarm output” (relay outputs QX2-4, operating lines 5891 – 5894) is appropriately configured, the error message will be forwarded or displayed by an additional contact (e.g. an external lamp or horn).

#### Minimum flow temperature setpoint TVHw

The adjusted minimum flow temperature setpoint will be activated via terminals H1/2 (e.g. an air heater function for a warm air curtain) closes its contact.



The setpoint must be set via operating line 5952.



### **Excess heat discharge**

Active dissipation of excessive heat enables an external heat source to force consumers (heating circuit, DHW storage tank, Hx pump) to draw excessive heat by delivering a forced signal.

The parameter "Excessive heat draw" can be used to determine for every consumer whether or not it should take account of the "forced" signal, and hence whether or not that consumer should participate in the dissipation of heat.

- Local effect

When using LPB device address 0 or >1, excessive heat dissipation only acts on the local consumers connected to the controller.

- Central effect (LPB)

When using LPB device address = 1, excessive heat dissipation also acts on the consumers connected to the other controllers in the same segment.

The distribution of excessive heat from segment 0 across other segments of the system is not possible.

### **Dew point monitor**

The dewpoint monitor detects the formation of condensate. If the dewpoint monitor responds to condensation, the cooling switches off immediately.

The cooling is enabled when the monitor is no longer signalling condensation and when a definable "locking time" (operating line 946) has expired.

### **Flow setpoint increase, hygostat**

If the hygostat responds, the flow setpoint is increased by the fixed value defined in "Flow setpt increase hygro" (operating line 947). As soon as the hygostat reverts to normal, the flow setpoint returns to the "normal value".

### **Refrigeration demand**

The refrigeration demand is transmitted to the refrigeration generating plant via a contact.



The setpoint must be set via operating line 5952.

### **Heat request 10 V**

Heat generation receives heat requests in the form of voltage signals (DC 0...10V).

The linear characteristic curve is defined via two fixed points (voltage value 1 / function value 1 and voltage value 2 / function value 2).

### **Refrig demand 10V**

Refrigeration generation receives the refrigeration demand in the form of a voltage signal (DC 0...10 V).

The linear characteristic curve is defined via two fixed points (voltage value 1 / function value 1 and voltage value 2 / function value 2).

### **Pressure measurement 10V**

The voltage signal present at input H... is converted into a linearized pressure value.

The linear characteristic curve is defined via two fixed points (voltage value 1 / function value 1 and voltage value 2 / function value 2).

### **Relative room humidity 10V**

The voltage signal present at input Hx is converted into a linearized relative humidity value. This is used for the dewpoint calculation and dewpoint protection functions of the cooling circuit and for control of the dehumidifier.

The linear characteristic curve is defined via two fixed points (voltage value 1 / function value 1 and voltage value 2 / function value 2).

### Room temperature 10V

The voltage signal present at input Hx is converted into a linearized room temperature value. This, in conjunction with the indoor relative humidity, is used to calculate the dewpoint temperature in the cooling circuit.

If there is no room unit with a room sensor (BSB) connected for heating/cooling circuit 1, the room temperature measured at Hx is also used for room heating/cooling 1 (variant with compensation and room influence).

The linear characteristic curve is defined via two fixed points (voltage value 1 / function value 1 and voltage value 2 / function value 2).

Contact type, input H...

### NC

The contact is normally closed and must be opened to activate the selected function.

### N/O

The contact is normally open and must be closed to activate the selected function.

Function value, contact H..

The function "Min flow temp setpoint" on operating line 5950 or 6046 is activated via contact H... The generating plant is controlled constantly at the temperature level set here, either until contact H.. opens again or until a higher heating/cooling demand is delivered.

Example of minimum flow setpoint:

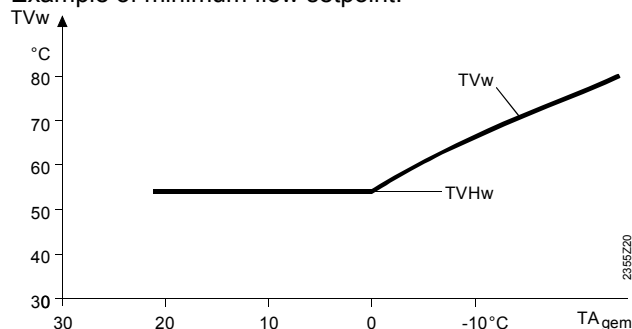

TVHw Minimum flow temperature setpoint  
TVw Flow temperature setpoint

Voltage value 1  
Function value 1  
Voltage value 2  
Function value 2

The linear characteristic is defined via two fixed points. The setting uses two parameter pairs for *Function value* and *Voltage value* (F1/U1 and F2/U2).

- Example for "Heating demand 10V" and "Cooling demand 10V"

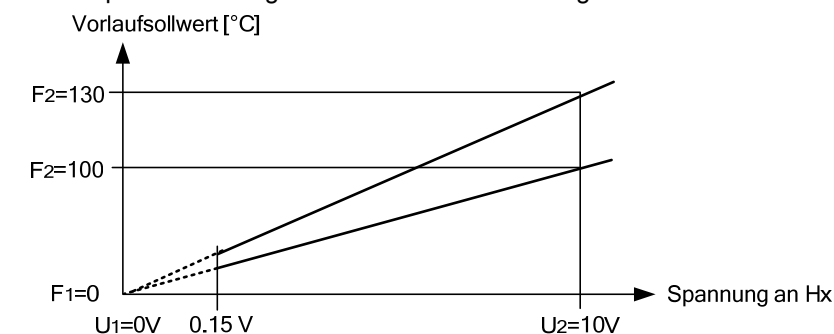

U1 Voltage value 1  
F1 Function value 1  
U2 Voltage value 2  
F2 Function value 2

If the input signal drops below the limit value of 0.15 V, the heating demand is invalid and therefore has no effect.

- Example of pressure measurement 10V

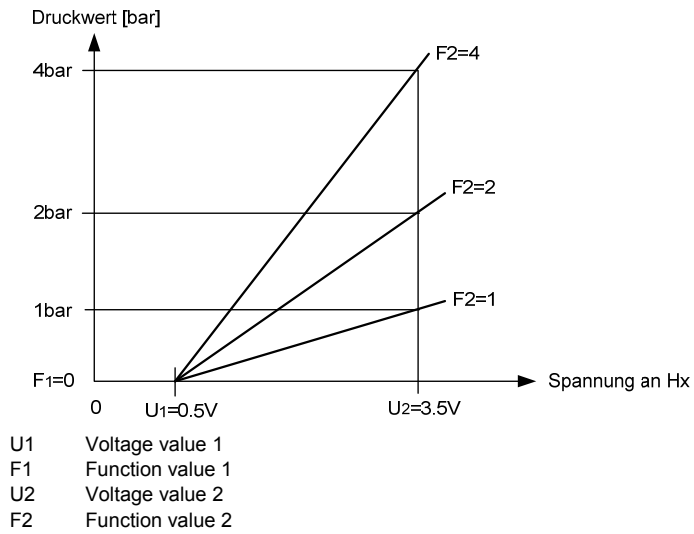

- Example of relative room humidity 10V

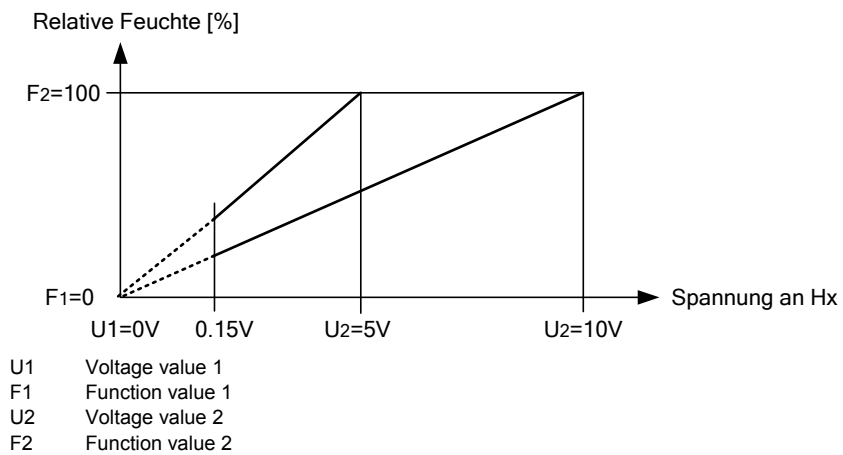

If the measured value is below 0.15V it is regarded as invalid and an error message is generated.

- Example of room temperature 10V

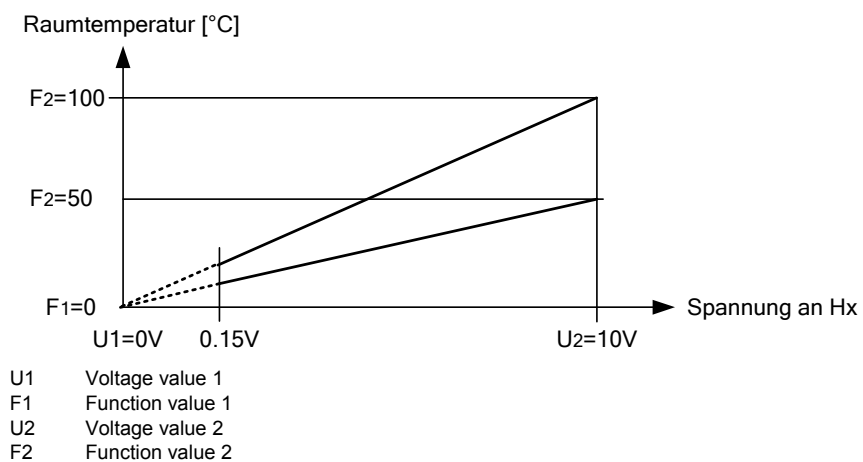

If the measured value is below 0.15V it is regarded as invalid and an error message is generated.

## Mixing valve groups basic unit

<i>Line no.</i>	<i>Operating line</i>
<b>6014</b>	<b>Function mixing group 1</b> Heating circuit 1/2 Primary controller / system pump DHW primary controller <sup>4)</sup> Instantaneous DHW heater <sup>4)</sup> Cooling circuit 1 Heating circuit/cooling circuit 1

The mixing valve groups are assigned to the following connections:

Mixing valve group 1
Q2, Y1, Y2, B1

### **Heating circuit 1/2**

For this application, the respective settings of operating page "Heating circuit 1/2" can be adapted.

### **Primary controller / system pump**

For this application, the respective settings of operating page "Primary controller / system pump" can be adapted.

### **DHW primary controller**

For this application, the respective settings of operating page "DHW storage tank" can be adapted.

### **Instantaneous DHW heater**

For this application, the respective settings of operating page "Instantaneous DHW heater" can be adapted.

### **Cooling circuit 1**

For this application, the respective settings of operating page "Cooling circuit 1" can be adapted.

### **Heating circuit/cooling circuit 1**

For this application, the respective settings of operating page "Heating circuit 1 and cooling circuit 1" can be adapted.

## Extension module

<b>6020, 6021</b>	<b>Function extension module 1, 2</b> None Multifunctional Heating circuit 2 Solar DHW <sup>4)</sup> Primary controller / system pump DHW primary controller <sup>4)</sup> Instantaneous DHW heater <sup>4)</sup> Cooling circuit 1
-----------------------	---

### Multifunctional

Functions that can be assigned to the multifunctional inputs / outputs appear on operating lines 6030, 6031, 6032 and 6040, 6041.

### Heating circuit 2

For this application, the respective settings of operating page "Heating circuit 2" can be adapted.

### Solar DHW

For this application, the respective settings of operating page "Solar" can be adapted.

### Primary controller / system pump

For this application, the respective settings of operating page "Primary controller / system pump" can be adapted.

### DHW primary controller

For this application, the respective settings of operating page "DHW storage tank" can be adapted.

### Instantaneous DHW heater

For this application, the respective settings of operating page "Instantaneous DHW heater" can be adapted.

### Cooling circuit 1

For this application, the respective settings of operating page "Cooling circuit 1" can be adapted.

Connections:

	QX21	QX22	QX23	BX21	BX22	H2	Page
<b>Multifunction</b>	*	*	*	*	*	*	
<b>Heating circuit 2</b>	Y5	Y6	Q6	B12	*	*	<b>51</b>
<b>Solar DHW heating</b>	*	*	Q5	B6	B31	*	51
<b>Primary controller</b>	Y19	Y20	Q14	B15	*	*	51
<b>DHW primary controller</b>	Y31	Y32	Q3	B35	*	*	51
<b>Instantaneous DHW heater</b>	Y33	Y34	Q34	B38	B39	Flow switch	51
<b>Cooling circuit 1</b>	Y23	Y24	Q24	B16	*	*	51

\* Freely selectable in QX.../ BX...

## QX extension module

Outputs can be configured for freely selectable QX.../ BX...

Line no.	Operating line
<b>6030</b>	<b>Relay output QX21, QX22, QX23</b>
<b>6031</b>	None
<b>6032</b>	Circulating pump Q4 <sup>4)</sup> El imm heater DHW K6 <sup>4)</sup> collector pump Q5 <sup>4)</sup> H1 pump Q15 Alarm output K10 2nd pump speed HC1 Q21 2nd pump speed HC2 Q22 2nd pump speed HCP Q23 Heat circ pump HCP Q20 H2 pump Q18 System pump Q14 Time program 5 K13 DHW mixing pump Q35 <sup>4)</sup> DHW interm circ pump Q33 <sup>4)</sup> Heat request K27 Refrig demand K28 Dehumidifier K29 Diverting valve, cooling Y21

Refer to function description, operating line "Relay output QX1".

## BX extension module

Can be configured for freely selectable QX.../ BX...

RVS46.543 only

Line no.	Operating line
<b>6040</b>	<b>Sensor input BX21, BX22</b>
<b>6041</b>	None DHW sensor B31 Collector sensor B6 DHW circulation sensor B39 DHW charging sensor B36 Solar flow sensor B63 Solar return sensor B64

See the function description for operating line "Sensor input BX1".

## H2 extension module

Line no.	Operating line
<b>6046</b>	<b>Function input H2</b> Optg mode changeover HCs+DHW Optg mode changeover HCs Optg mode changeover HC1 Optg mode changeover HC2 Optg mode changeover HCP Error/alarm message Min flow temp setpoint Excess heat discharge Dew point monitor Flow setpt increase hygro Refrigeration demand Heat request 10V Refrig demand 10V Pressure measurement 10V Relative room humidity 10V Room temperature 10V
<b>6047</b>	<b>Contact type H2</b> NC N/O
<b>6048</b>	<b>Function value, contact H2</b>
<b>6049</b>	<b>Voltage value 1, H2</b>
<b>6050</b>	<b>Function value 1, H2</b>
<b>6051</b>	<b>Voltage value 2, H2</b>
<b>6052</b>	<b>Function value 2, H2</b>

The settings for input H2 on the extension module are the same as those of the H.. inputs on the basic unit. They are described under the operating line "Function of input H..". Siehe dazu Seite 51.

### Types of sensor/readjustment

Line no.	Operating line
RVS46.543 only <b>6097</b>	<b>Sensor type collector</b> NTC 10k Platinum 1000
RVS46.543 only <b>6098</b>	<b>Readjustm collector sensor</b>
<b>6100</b>	<b>Readjustm outside sensor</b>

**Sensor type collector** Selection of type of sensor used. The controller will use the respective temperature characteristic.

**Readjustm collector sensor** The measured value can be corrected.

### Building and room model

Line no.	Operating line
<b>6110</b>	<b>Time constant building</b>

When the outside temperature varies, the room temperature changes at different rates, depending on the building's thermal storage capacity (Construction).

The above setting is used to adjust the response of the flow temperature setpoint when the outside temperature varies.

- Example:
  - > 20 hours  
The room temperature responds *more slowly* to outside temperature variations.
  - 10 - 20 hours  
This setting can be used for most types of buildings.
  - < 10 hours  
The room temperature responds *more quickly* to outside temperature variations.

### Frost protection for the plant

Line no.	Operating line
<b>6120</b>	<b>Frost protection plant</b>

The pumps are activated depending on the **current** outside temperature, even if there is no heat request.

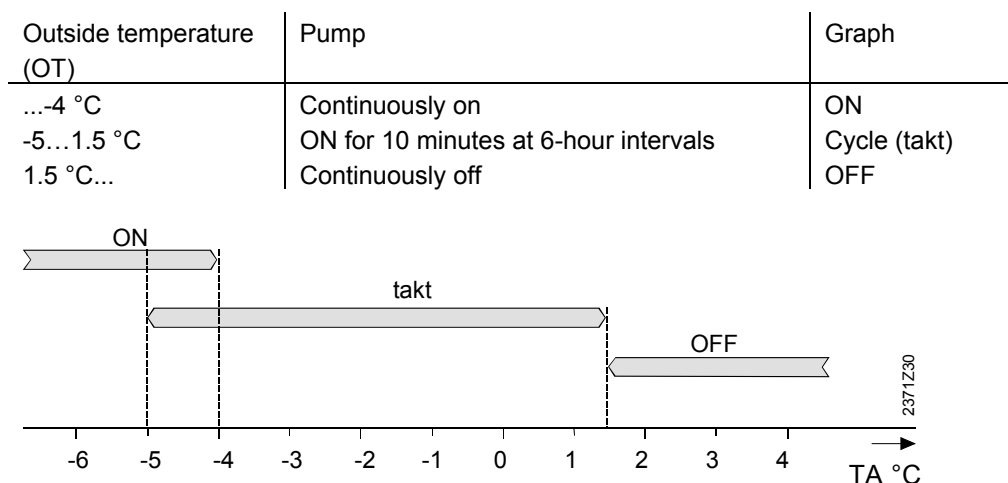

## External requirements

RVS46.543 only

Line no.	Operating line
<b>6128</b>	<b>Heat request below OT</b>
<b>6129</b>	<b>Heat request above OT</b>
<b>6131</b>	<b>Heat req in economy mode</b> Off   On DHW   On

### Heat request below OT

The heat source (K27 with QX... or output UX) is put into operation only if the outside temperature lies below / above the threshold.

### Heat req in economy mode

Economy mode can be selected from menu "Special operation / service" (operating line 7139).

In Economy mode, the heat source (K27 with QX.. or output UX) operates as follows:

- Off: Remains locked
- Only DHW: Released for DHW charging
- On: Always released.

## Air dehumidifier

Line no.	Operating line
<b>6135</b>	<b>Air dehumidifier</b>
<b>6136</b>	<b>Air dehumidifier enable</b>
<b>6137</b>	<b>Air dehumidifier r.h. EIN</b>
<b>6138</b>	<b>Air dehumidifier r.h. SD</b>

An external air dehumidifier can be switched on increased room air humidity with a selectable relay *Air dehumidifier K29* on a QX output.

release The parameter *Air dehumidifier* can switch on and off the air dehumidifier:

- On: Operation per setting parameter *Enable Air Dehumidifier*.
- Off: Switched off.

Program selection The parameter *Enable air dehumidifier* determines the program used with the air dehumidifier:

- 24 h/day: Continuous operation, independent of scheduler.
- Time program, heating circuit: Operation per scheduler heating circuit 1.
- Time program 5: Operation per time program 5.

## Control

The air dehumidifier (K29) is switched on when the measured relative air humidity exceeds the set switch-on point. The air dehumidifier is switch off again when room humidity drops below the set switching difference.

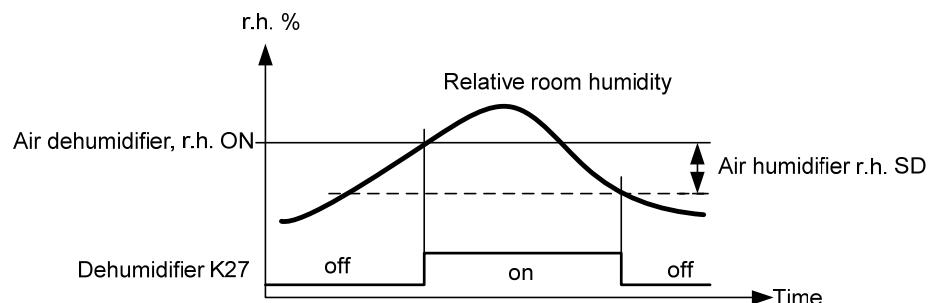

Relative room humidity is measured via any Hx input with the functions *Relative room humidity 10V*.



### Sensor state

<i>Line no.</i>	<i>Operating line</i>
<b>6200</b>	<b>Save sensors</b>

At midnight, the basic unit stores the states at the sensor terminals.  
 If, after storage, a sensor fails, the basic unit generates an error message.  
 This setting is used to ensure immediate saving of the sensors. This becomes a requirement when, for instance, a sensor is removed because it is no longer needed.

### Parameter reset

<i>Line no.</i>	<i>Operating line</i>
<b>6205</b>	<b>Reset to default parameters</b>

All parameters can be set to their default values. Exempted from this are the following operating pages: Time of day and date, operator unit, radio and all time programs, as well the setpoint manual control.

### Plant diagram

RVS46.543 only

<i>Line no.</i>	<i>Operating line</i>
<b>6212</b>	<b>Check-No. heat source 1</b>
<b>6215</b>	<b>Check-No. storage tank</b>
<b>6217</b>	<b>Check-No. heating circuits</b>

To identify the current plant diagram, the basic unit generates a check number.  
 The check number is made up of the lined up part diagram numbers.

### Structure of control number

Every control number consists of 3 columns, each representing the application of a plant component. Every column shows a number with a maximum of 2 digits. Exception is the first column. If the first digit in the first column is a 0, the 0 will be hidden.

Operating line	First column 2 digits	Second column 2 digits	Third column 2 digits
BZ6212		Solar	
BZ6215			DHW storage tank
BZ6217	Heating circuit P	Heating circuit 2	Heating circuit 1

### Check-No. heat source 1

	<b>Solar</b>	<b>Oil / gas boiler</b>
0	No solar	00 No boiler
1	Solar with collector sensor and pump	

### Check-No. storage tank

	<b>DHW storage tank</b>
0	No DHW storage tank
1	electric immersion heater
2	Solar connection
4	Charging pump
5	Charging pump, solar connection
13	Diverting valve
14	Diverting valve, solar connection

check no. heating circuit

Heating circuit P		Heating circuit 2		Heating circuit 1	
0	No heating circuit	00	No heating circuit	0	No heating circuit
2	heating circuit pump	02	heating circuit pump	1	Cirkulation via Boiler pump
		03	Heating circuit pump Mixing valve	2	heating circuit pump
				3	Heating circuit pump, mixing valve
				5..7	Heating/cooling, 2-pipe, Common distribution
				8..10	Cooling only, 2-pipe
				12	Heating/cooling, 4-pipe, Common distribution
				14..16	Heating/cooling, 4-pipe, Common distribution
				20..27	Heating/cooling, 2-pipe, separate distribution
				30..38	Heating/cooling, 4-pipe, Separate distribution.
				40..42	Cooling only, 4-pipe

Example

Heat source Solar with collector sensor and pump  
 Storage tank: Charging pump and solar connection  
 Heating circuit 1: Heating circuit pump and mixing valve

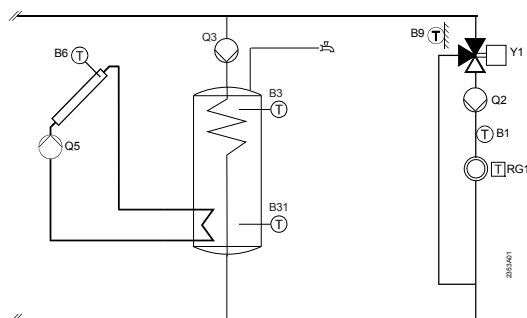

Displays on the operator unit:

Check-No. heat source 1					1	0	0
Check-No. storage tank							5
check no. heating circuit							3

Device data

Line no.	Operating line
<b>6220</b>	<b>Software version</b> The software version indicated here represents the current version of the basic unit.

## 6.15 LPB system

Address / power supply

Line no.	Operating line
<b>6600</b>	<b>Device address</b>
<b>6601</b>	<b>Segment address</b>
<b>6604</b>	<b>Bus power supply function</b> Off Automatically
<b>6605</b>	<b>Bus power supply state</b> Off On

- Bus power supply                      The bus power supply enables the bus system to be powered directly by the individual controllers (no central bus power supply). The type of bus power supply can be selected.
- Off: No bus power supply via the controller.
  - Automatically: The bus power supply (LPB) via the controller is automatically switched on and off depending on the requirements of the LPB.
- Bus power supply state                The display shows whether the controller currently supplies power to the bus:
- Off: The bus power supply via controller is currently inactive.
  - On: The bus power supply via controller is currently active. At the moment, the controller supplies some of the power required by the bus.

**Central functions**

<i>Line no.</i>	<i>Operating line</i>
<b>6621</b>	<b>Summer changeover</b> Locally; Centrally
<b>6623</b>	<b>Optg mode changeover</b> Locally; Centrally
<b>6625</b>	<b>DHW assignment</b> Local HCs All HCs in the segment: All HCs in system
<b>6627</b>	<b>Refrigeration demand</b> Locally; Centrally



These settings are only relevant for device address 1.

Range of action of changeover

The range of action of central changeover can be defined. This concerns:

- Summer changeover (when selecting "Central" on line 6623)
- Summer changeover (with "Central" setting on operating line 6621)

Entries:

- Segment: Changeover takes place with all controllers in the same segment.
- System: Changeover takes place with all controllers in the entire system (in all segments). The controller must be located in segment 0!

Summer changeover

The scope of summer changeover is as follows:

- Locally:  
Local action; the local heating circuit is switched based on operating lines 730, 1030 and 1330.
- Centrally:  
Central action; depending on the setting made on operating line "Action changeover functions", either the heating circuits in the segment or those of the entire system are switched based on operating line 730.

Optg mode changeover

The range of action of operating mode changeover input via input H is as follows:

- Locally:  
Local action; the local heating circuit is switched on and off.
- Centrally:  
Central action; depending on the setting made on operating line "Action changeover functions", either the heating circuits in the segment or those of the entire system are switched based on operating line 730.

Manual source lock

The range of the generation lock via H input is as follows:

- Locally:  
Local action; the local source is locked.
- Centrally:  
Central action; all sources of the cascade are locked.

Assignment of DHW heating

Assignment of DHW heating is required only if it is controlled by a heating circuit program (refer to operating lines 1620 and 5061).

Settings:

- Local HCs:  
DHW is only heated for the local heating circuit
- All HCs in the segment:  
DHW is heated for all HCs in the segment
- All HCs in the system:  
DHW is heated for all heating circuits in the system.

With all settings, controllers in holiday mode are also considered for DHW heating.

Refrigeration demand

"Refrigeration demand K28" sets the relay parameter on the QX.. for the output of the refrigeration demand.

Depending on the setting (local/central) the demand is transmitted by the local cooling circuit or all cooling circuits in the system. This option applies only to the device with device address 1.

Ext source with eco mode

Economy mode can be selected from menu "Special operation / service" (operating line 7139).

In Economy mode, external heat sources on the LPB are operated as follows:

- Off: Remains locked
- DHW only: Released for DHW charging
- On: Always released.

## Clock

<b>6640</b>	<b>Clock mode</b> Autonomously Slave without remote Slave with remote setting Master
<b>6650</b>	<b>Outside temp source</b>

Clock mode

This setting defines the impact of the system time on the controller's time setting. The impact is as follows :

- Autonomously: The time of day on the controller can be readjusted  
The controller's time of day is not matched to the system time
- Slave without remote adjustment: The time of day on the controller cannot be readjusted  
The controller's time of day is constantly and automatically matched to the system time
- Slave with remote adjustment: The time of day on the controller can be readjusted; at the same time, the system time is readjusted since the change is adopted from the master.  
The controller's time of day is still automatically and constantly matched to the system time
- Master: The time of day on the controller can be readjusted  
The time of day on the controller is used for the system. The system time will be readjusted

Outside temperature source

Only 1 outside temperature sensor is required in the LPB plant. This sensor is connected to a freely selectable controller and delivers via LPB the signal to the controllers without sensor.  
The first numeral to appear on the display is the segment no. followed by the device no.

## 6.16 Faults

When a fault  is pending, an error message can be displayed on the info level by pressing the Info button. The display describes the cause of the fault.

Acknowledgements

<i>Line no.</i>	<i>Operating line</i>
<b>6710</b>	<b>Reset alarm relay</b>

When a fault is pending, an alarm can be triggered via relay QX... The QX... relay must be appropriately configured.

This setting can be used to reset the alarm relay.

Temperature alarms

RVS46.543 only

<i>Line no.</i>	<i>Operating line</i>
<b>6740</b>	<b>Flow temp 1 alarm</b>
<b>6741</b>	<b>Flow temp 2 alarm</b>
<b>6745</b>	<b>DHW charging alarm</b>
<b>6746</b>	<b>Flow temp alarm, cooling 1</b>

The difference of setpoint and actual temperature is monitored. A control offset beyond the set period of time triggers an error message.

Error history

<i>Line no.</i>	<i>Operating line</i>
<b>6800...6819</b>	<b>History ...</b>

The basic unit stores the last 10 faults in non-volatile memory. Any additional entry deletes the oldest in the memory. For each error entry, error code and time of occurrence is saved.

## 6.17 Maintenance / special mode

Maintenance functions

RVS46.543 only

RVS46.543 only

<i>Line no.</i>	<i>Operating line</i>
<b>7044</b>	<b>Maintenance interval</b>
<b>7045</b>	<b>Time since maintenance</b>
<b>7119</b>	<b>Economy function</b> Locked released
<b>7120</b>	<b>Economy mode</b> Off   On

Economy function

**Locked**  
Economy mode is not possible.

**Released**  
Economy mode can be activated.

Economy mode

Switches economy mode on or off

## Manual operation

Line no.	Operating line
<b>7140</b>	<b>Manual control</b>

When manual control is activated, the relay outputs are no longer energized and deenergized according to the control state but are set to a predefined manual control state in accordance with their functions (see table below).

The burner relay energized in manual control can be deenergized by the electronic temperature controller (TR).

Designation		Relay	State
Solar	Collector pump	Q5	Off
DHW	Charging pump	Q3	On
	Diverting valve	Q3	Off
	Mixing pump	Q32	Off
	Intermediate circuit pump	Q33	On
	Mixing valve opening / closing	Y31/Y32	Off
	Instantaneous DHW heater pump	Q34	On
	Instantaneous DHW heater on / off	Y33/Y34	Off
	Circulating pump	Q4	On
	electric immersion heater	K6	On
Heating circuit 1...3	heating circuit pump	Q2 Q6 Q20	On
	Heating circuit mixing valve opening / closing	Y1 / Y2 Y5 / Y6	Off
	Heating circuit pump 2nd speed	Q21 Q22 Q23	On
Cooling circuit 1	Cooling circuit pump	Q24	On
	Cooling circuit mixing valve opening / closing	Y23/Y24	Off
	Diverting valve for cooling	Y21	Off
Primary controller	System pump	Q14	On
	Mixing valve opening / closing	Y19/Y20	Off
Hx group	Pump H1	Q15	On
	Pump H2	Q18	On
	Pump H3	Q19	On
Auxiliary functions	Alarm output	K10	Off
	Time program 5	K13	Off
	Heat demand	K27	On
	Refrigeration demand	K28	Off
	Storage tank transfer pump	Q11	Off

Setpoint adjustment in manual control

After manual control has been activated, a change to the basic display must be made. There, the maintenance / special mode symbol  appears.

Press the info button to switch to info display "Manual mode", where the setpoint can be adjusted.

## Simulations

Line no.	Operating line
<b>7150</b>	<b>Simulation outside temp</b>

To facilitate commissioning and fault tracing, outside temperatures in the range from – 50 to +50°C can be simulated. During simulation, the actual, the composite and the attenuated outside temperature will be overridden by the set simulated temperature. During simulation, calculation of the 3 mentioned outside temperatures continues and the temperatures are available again when simulation is completed.



The function is deactivated by setting -.- on this operating line, or automatically after a timeout of 1 hour.

## Telephone customer service

<i>Line no.</i>	<i>Operating line</i>
<b>7170</b>	<b>Telephone customer service</b>

Setting of phone number that appears on the info display.

## 6.18 Input / output test

<i>Line no.</i>	<i>Operating line</i>
<b>7700...7999</b>	

The input / output test is used to check the correct functioning of the connected components.

When selecting a setting from the relay test, the relevant relay is energized, thus putting the connected component into operation. The correct functioning of the relays and wiring can thus be tested.

## 6.19 State

The current operating state of the plant is visualized by means of status displays.

### Messages

Line no.	Operating line
<b>8000</b>	<b>State of heating circuit 1</b>
<b>8001</b>	<b>State of heating circuit 2</b>
<b>8002</b>	<b>State heating circuit P</b>
<b>8003</b>	<b>State of DHW</b>
<b>8007</b>	<b>State of solar</b>

RVS46.543 only

### State heating circuit

End user (info level)	Commissioning, heating engineer	
Limit thermostat has cut out	Limit thermostat has cut out	3
Manual control active	Manual control active	4
Floor curing function active	Floor curing function active Overtemp protection active Restricted, boiler protection Restricted, DHW priority Restricted, buffer priority	102 56 103 104 105
Heating mode restricted	Forced discharging buffer storage tank Forced discharging DHW Forced discharging heat source Zwansabnahme Overrun active	106 107 108 109 110 17
Forced heat release	Opt start control + boost heating Optimum start control Boost heating	110 111 112 113
Heating mode Comfort	Heating mode Comfort Optimum stop control	114 115
Heating mode Reduced	Heating mode Reduced Frost protection room active Frost protection flow active Frost protection plant active	116 101 117 23
Frost protection active		24
Summer operation	Summer operation 24-hour Eco active Setback Reduced Setback frost protection Room temp lim	118 119 120 121 122
Off	Off	25

### Cooling

End user (info level)	Commissioning, heating engineer	
Dewpoint monitor active	Dewpoint monitor active	133
Manual control active	Manual control active	4
Fault	Fault	2
Frost protection active	Frost protection flow active	117 24
Cooling mode locked	Locking period at end of heating Locked, energy source Locked, buffer	135 205 206 146
Cooling mode, restricted	Flow setpt increase hygro Min. flow limit, dewpoint Min. flow limit, outside temp	136 177 178 144
Cooling mode, Comfort	Cooling mode, Comfort Overrun active	150 17 150
Protection mode, cooling	Protection mode, cooling	149
Frost protection active	Frost protection plant active	23 24
Cooling limit OT active	Cooling limit OT active	134
Off	Off Room temp lim Flow limit reached	25 122 179 25
Cooling mode off	Cooling mode off	138



State of DHW

<i>End user (info level)</i>	<i>Commissioning, heating engineer</i>	
Limit thermostat has cut out	Limit thermostat has cut out	3
Manual control active	Manual control active	4
Draw-off mode	Draw-off mode	199
Recooling active	Recooling via collector	77
	Recooling via DHW/HCs	78
		53
Charging lock active	Discharging protection active	79
	Charging time limitation active	80
	DHW charging locked	81
		82
Forced charging active	Forced, max stor tank temp	83
	Forced, max charging temp	84
	Forced, legionella setpoint	85
	Forced, nominal setpoint	86
		67
Charging el im heater	Charging electric, leg setpoint	87
	Charging electric, nominal setpoint	88
	Charging electric, Red setpoint	89
	Charging electric, frost setpoint	90
	El imm heater released	91
		66
Push active	Push, leg setpoint	92
	Push, nominal setpoint	93
		94
Charging active	Charging, leg setpoint	95
	Charging, nominal setpoint	96
	Charging, reduced setpoint	97
		69
Frost protection active	Frost protection active	24
Overrun active	Overrun active	17
Stand-by charging	Stand-by charging	201
Charged	Charged, max stor temp	70
	Charged, max charg temp	71
	Forced, legio temp	98
	Forced, nominal temp	99
	Forced, Reduced temp	100
		75
Off	Off	25
Ready	Ready	200

State of solar

<i>End user (info level)</i>	<i>Commissioning, heating engineer</i>	
Manual control active	Manual control active	4
Fault	Fault	2
Frost protection collector active	Frost protection collector active	52
Recooling active	Recooling active	53
Max stor tank temp reached	Max stor tank temp reached	54
Evaporation protection active	Evaporation protection active	55
Overtemp protection active	Overtemp protection active	56
Max charg temp reached	Max charg temp reached	57
Charging DHW	Charging DHW	58
Charging buffer storage tank	Charging buffer storage tank	59
Radiation insufficient	Min charg temp not reached	61
Radiation insufficient	Temp diff insufficient	62
Radiation insufficient	Radiation insufficient	63

## 6.20 Diagnostics, heat generation

---

For diagnostic purposes, the various setpoints, actual values, relay switching states and meter readings can be displayed.

RVS46.543 only

<i>Line no.</i>	<i>Operating line</i>
<b>8610...8699</b>	

## 6.21 Diagnostics, consumers

---

For diagnostic purposes, the various setpoints, actual values, relay switching states and meter readings can be displayed.

<i>Line no.</i>	<i>Operating line</i>
<b>8700...9099</b>	

## 6.22 List of displays

Priorities are assigned to pending errors. From priority 6, alarm messages are delivered, which are used by remote supervision (OCI). In addition, the alarm relay will be set.

### 6.22.1 Error code

Error code	Description of error	Priority
0	No error	
10	Outside temperature sensor error	6
20	Boiler temperature 1 sensor error	9
25	Solid fuel boiler temperature (wood) sensor error	9
26	Common flow temperature sensor error	6
28	Flue gas temperature sensor error	6
30	Flow temperature 1 sensor error	6
31	Flow temperature 1 cooling, sensor error	6
32	Flow temperature 2 sensor error	6
38	Flow temperature primary controller sensor error	6
40	Return temperature 1 sensor error	6
46	Return temperature cascade sensor error	6
47	Common return temperature sensor error	6
50	DHW temperature 1 sensor error	9
52	DHW temperature 2 sensor error	9
54	DHW primary controller sensor error	6
57	DHW circulation temperature sensor error	6
60	Room temperature 1 sensor error	6
65	Room temperature 2 sensor error	6
68	Room temperature 3 sensor error	6
70	Buffer storage tank temperature 1 sensor error	6
71	Buffer storage tank temperature 2 sensor error	6
72	Buffer storage tank temperature 3 sensor error	6
73	Collector temperature 1 sensor error	6
74	Collector temperature 2 sensor error	6
81	Short-circuit LPB	6
82	LPB address collision	3
83	BSB wire short-circuit	6
84	BSB address collision	3
85	BSB radio communication fault	6
98	Extension module 1 fault (common fault status message)	6
99	Extension module 2 fault (common fault status message)	6
100	2 clock time masters (LPB)	3
102	Clock time master without backup (LPB)	3
105	Maintenance message	5
109	Boiler temperature supervision	9
110	Lockout by SLT	9
117	Upper pressure limit (crossed)	6
118	Critical lower pressure limit (crossed)	6
121	Flow temperature 1 (HC1) supervision	6
122	Flow temperature 2 (HC2) supervision	6
126	DHW charging supervision	6
127	Legionella temperature not reached	6
131	Burner fault	9
146	Configuration error common message	3
171	Alarm contact 1 (H1) active	6
172	Alarm contact 2 (H2) active	6
173	Alarm contact 3 (EX2/230VAC) active	6
174	Alarm contact 4 (H3) active	6
176	Upper pressure limit 2 (crossed)	6
177	Critical lower pressure limit 2 (crossed)	6
178	Temperature limiter heating circuit 1	3
179	Temperature limiter heating circuit 2	3
207	Error, cooling circuit	6
217	Sensor error common message	6
217	Sensor error common message	6
218	Pressure supervision common message	6
241	Flow sensor, solar sensor error	6
242	Return sensor, solar sensor error	6

243	Swimming pool temperature sensor error	6
320	DHW charging temperature sensor error	6
321	Instantaneous DHW heater outlet temperature sensor error	6
322	Upper pressure limit 3 (crossed)	6
323	Critical lower pressure limit 3 (crossed)	6
324	BX same sensors	3
325	BX/extension module same sensors	3
326	BX/mixing valve group same sensors	3
327	Extension module same function	3
328	Mixing valve group same function	3
329	Extension module / mixing valve group same function	3
330	Sensor BX1 no function	3
331	Sensor BX2 no function	3
332	Sensor BX3 no function	3
333	Sensor BX4 no function	3
334	Sensor BX5 no function	3
335	Sensor BX21 no function	3
336	Sensor BX22 no function	3
337	Sensor BX1 no function	3
338	Sensor BX12 no function	3
339	Collector pump Q5 missing	3
340	Collector pump Q16 missing	3
341	Collector sensor B6 missing	3
342	Solar DHW sensor B31 missing	3
343	Solar integration missing	3
344	Solar controlling element buffer K8 missing	3
345	Solar controlling element swimming pool K18 missing	3
346	Solid fuel boiler pump Q10 missing	3
347	Solid fuel boiler comparison sensor missing	3
348	Solid fuel boiler address error	3
349	Buffer return valve Y15 missing	3
350	Buffer storage tank address error	3
351	Primary controller / system pump address error	3
352	Pressureless header address error	3
353	Cascade sensor B10 missing	3
357	Flow temperature cooling circuit 1 monitoring	6
366	Room temperature Hx sensor error	6
367	Relative room humidity Hx sensor error	6
368	Flow setpoint correction Hx sensor error	6

## 6.22.2 Maintenance code

Maintenance code	Description of maintenance	Priority
1	Burner hours run exceeded	6
2	Burner starts exceeded	6
3	Maintenance interval exceeded	6
5	Water pressure heating circuit too low (dropped below lower pressure limit 1)	9
18	Water pressure 2 heating circuit too low (dropped below lower pressure limit 2)	9
10	Replace battery of outside sensor	6
21	Maximum flue gas temperature exceeded	6
22	Water pressure 3 heating circuit too low (dropped below lower pressure limit 3)	9

## 6.22.3 Special operation code

Special operation code	Description
301	manual operation
302	SLT test
303	Chimney sweep function
309	Simulation outside temperature
310	Alternative energy operation
314	Economy mode

# 7 Plant diagrams

The various applications are shown in the form of basic diagrams and extra functions. The basic diagrams show possible applications that can be implemented without using the multifunctional outputs.

## 7.1 Basic diagrams

The basic diagrams are examples of plant that can be implemented with standard outputs requiring only a few settings.

### 7.1.1 Basic diagram RVS46.543

Standard diagram

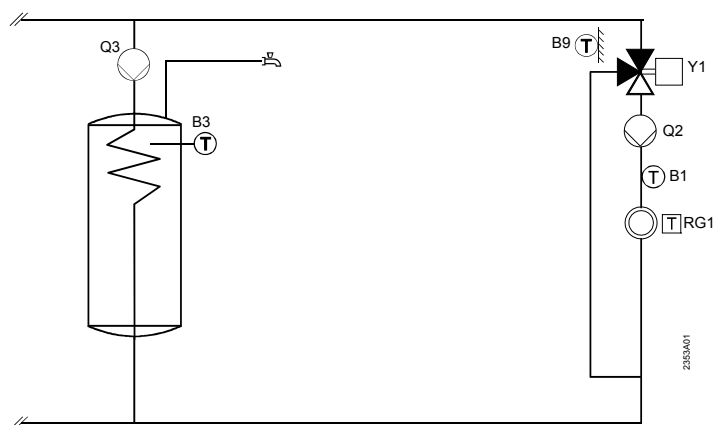

### 7.1.2 Basic diagram RVS46.530

Standard diagram

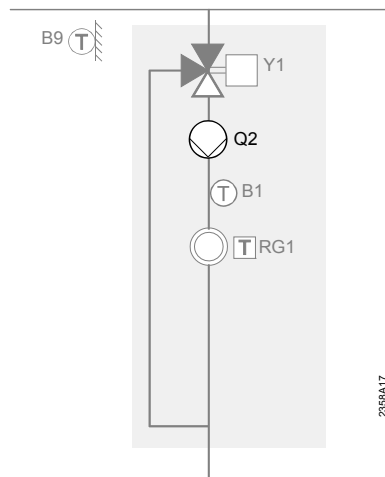

## 7.2 Extra functions in general

The extra functions can be selected via operating page "Configuration" and complement the basic diagrams of the respective controllers.

The type and number of extra functions that can be applied depend on the multifunctional outputs and inputs QX... or BX...

Depending on the type of application, the use of extra functions necessitates a number of appropriate operating line settings.

### Solar

RVS46.543 only

DHW charging collector pump,  
collector sensor

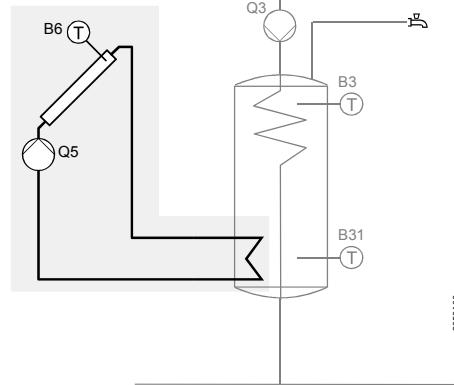

### DHW storage tank (DHW)

RVS46.543 only

DHW circulating pump

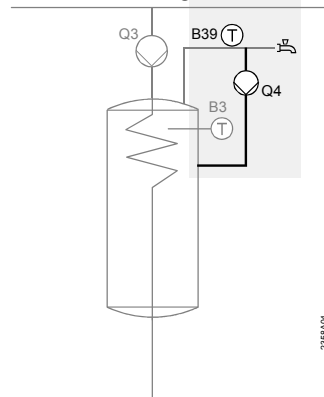

DHW el imm heater

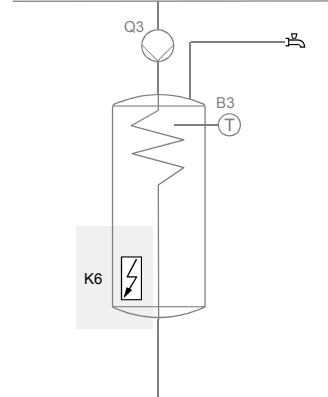

2. DHW sensor

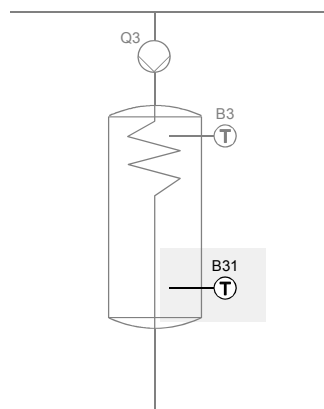

DHW tank with external heat exchanger,  
charging pump, intermediate circuit pump

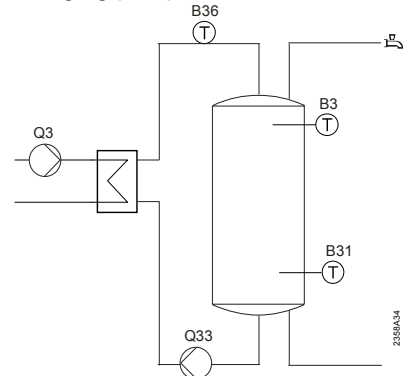

## Heating/cooling circuit

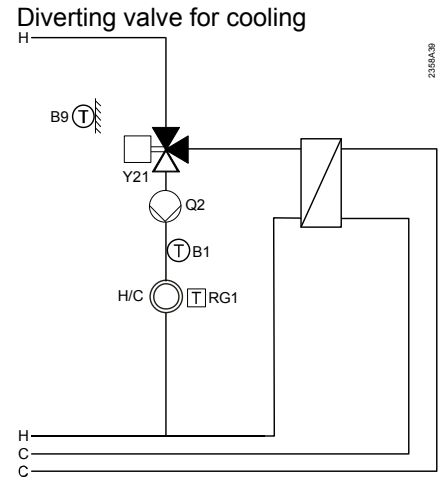
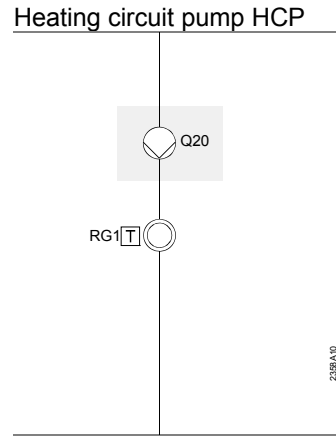

## Heat converter

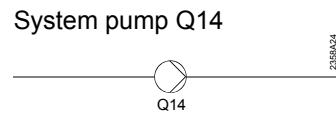

## Extra functions

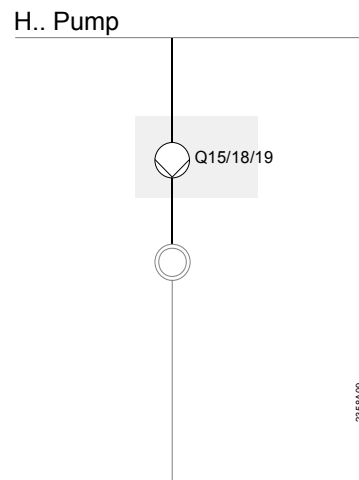

## 7.3 Extra functions with extension module AVS75.390

The extra functions can be selected via operating page "Configuration", operating lines 6020 and 6021, and supplement the basic diagrams of the respective controllers.

### 2. Mixing valve heating circuit

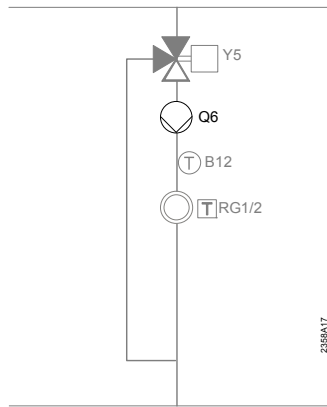

### Cooling circuit

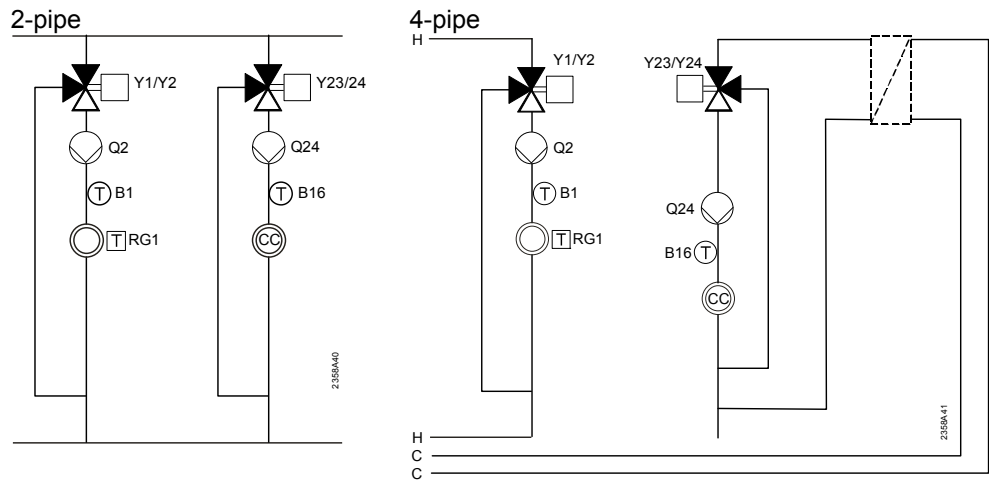

### Solar DHW heating

46.543 only

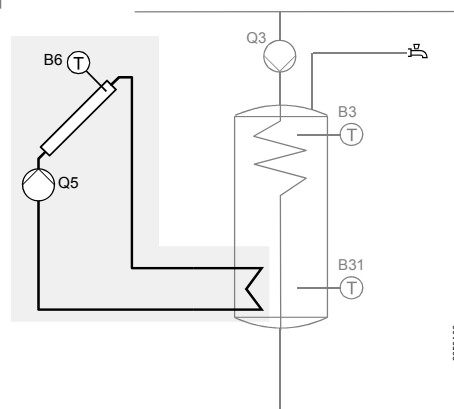



**Primary controller**

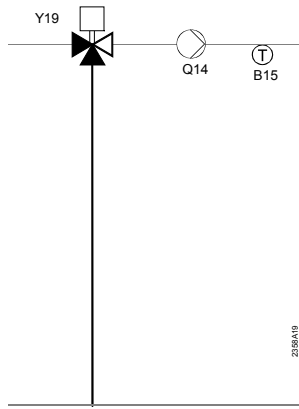

**Primary DHW controller**

46.543 only

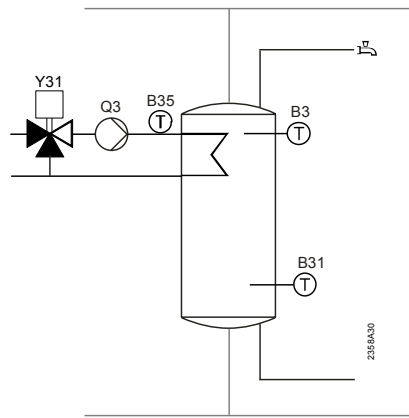

**Instantaneous DHW heater**

46.543 only

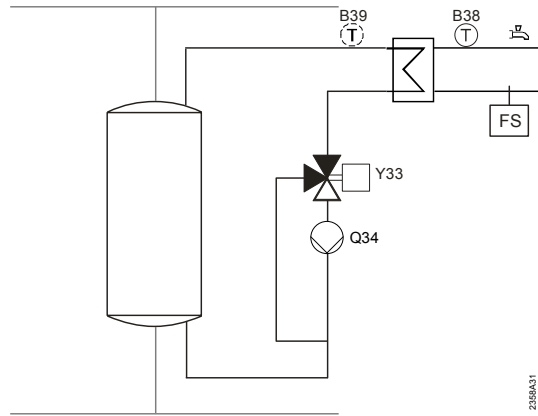

## Legend mains voltage

<i>Diagram</i>	<i>Function</i>
Q2	1. heating circuit pump
Q3	DHW charging pump / diverting valve
Q4	Circulating pump
Q5	Collector pump
Q6	2. heating circuit pump
Q14	System pump
Q15/18	Pump H1/2
Q20	Heating circuit pump HCP
Q24	Cooling circuit pump
Q33	DHW intermediate circuit pump
Q34	Instantaneous heater pump
Y1	1. Heating circuit mixing valve opening
Y2	1. Heating circuit mixing valve closing
Y5	2. Heating circuit mixing valve opening
Y6	2. Heating circuit mixing valve closing
Y21	Diverting valve for cooling
Y23	Kühlkreismischer AUF
Y24	Kühlkreismischer ZU
Y31	DHW primary controller mixing valve opening
Y32	DHW primary controller mixing valve closing
Y33	Instantaneous DHW heater valve opening
Y34	Instantaneous DHW heater valve closing
K6	electric immersion heater

## Legend low-voltage

B1	Flow temperature sensor HK1
B12	Flow temperature sensor HK2
B3	DHW sensor top
B31	2nd DHW sensor bottom
B35	DHW flow temperature sensor
B36	DHW charging sensor
B38	DHW temperature outlet sensor
B15	Flow sensor primary controller
B16	Flow sensor cooling circuit
B39	DHW circulation sensor B39
B6	Collector sensor
B9	Outside sensor
RG1	Room unit 1
RG2	Room unit 2
FS	Flow switch

## 8 Technical data

### 8.1 Basic units RVS...

<b>Power supply</b>	Rated voltage	AC 230 V ( $\pm 10\%$ )
	Bemessungsfrequenz	50/60 Hz
	Power consumption	RVS46.543: 8 VA RVS46.530: 8 VA
<b>Wiring of terminals</b>	Fusing of supply lines	max. 10 AT
	Power supply and outputs	solid wire or stranded wire (twisted or with ferrule): 1 core: 0.5...2.5 mm <sup>2</sup> 2 cores: 0.5. mm <sup>2</sup> ..1.5 mm <sup>2</sup> 3 cores: not permitted
<b>Functional data</b>	Software class	A
	Mode of operation to EN 60 730	1.B (automatic)
<b>Inputs</b>	Digital inputs H1 and H2	safety extra low-voltage for potentialfree low-voltage contacts: voltage with contact open: DC 12 V current with contact closed: DC 3 mA
	Analog input H1, H2	protective extra low-voltage operating range: DC (0...10) V internal resistance: > 100 k $\Omega$
	Mains voltage S3, 4 and EX2	AC 230 V ( $\pm 10\%$ ) internal resistance: > 100 k $\Omega$
	Sensor input B9	NTC1k (QAC34)
	Sensor inputs B1, B3, B12, BX1, BX2	NTC10k (QAZ36, QAD36)
	Sensor inputs BX1...BX2	PT1000 (optionally for collector and flue gas sensor)
	Perm. sensor cables (copper) with cross-sectional area: Max. length:	0.25 0.5 0.75 1.0 1.5 mm <sup>2</sup> 20 40 60 80 120 m
<b>Outputs</b>	Relay outputs	
	Rated current range	AC 0.02...2 (2) A
	Max. switch-on current	15 A for $\leq 1$ s
	Max. total current (of all relays)	AC 10 A
	Rated voltage range	AC (24...230) V (for potentialfree outputs)
<b>Interfaces, cable lengths</b>	BSB	2-wire connection, not interchangeable
	Max. cable length	
	Basic unit – peripheral device	200 m
	Max. total length	400 m (max. cable capacitance) 60 nF)
	Min. cross-sectional area	0.5 mm <sup>2</sup>
	LPB	(copper cable 1.5 mm <sup>2</sup> , 2-wire <b>not</b> interchangeable)
	with bus power supply via controller (per controller)	250 m 460 m
	With central bus power supply	E = 3
	Bus loading number	

<b>Degree of protection and safety class</b>	Degree of protection of housing to EN 60 529	IP 00
	Safety class to EN 60 730	low-voltage-carrying parts meet the requirements of safety class II, if correctly installed
	Degree of pollution to EN 60 730	Normal pollution
<b>Standards, safety, EMC, etc.</b>	CE conformity to	
	EMC directive	89/336/EEC
	- Immunity	- EN 61000-6-2
	- Emissions	- EN 61000-6-3
<b>Climatic conditions</b>	Low-voltage directive	73/23/EEC
	- Electrical safety	- EN 60730-1, EN 60730-2-9
	Storage to IEC721-3-1 class 1K3	temp. -20...65 °C
	Transport to IEC721-3-2 class 2K3	temp. -25...70°C
<b>Weight</b>	Operation to IEC721-3-3 class 3K5	temp. 0...50 °C (noncondensing)
	Without packaging	RVS46.543: 587 g
		RVS46.530: 431 g

## 8.2 Extension module AVS75.390

<b>Power supply</b>	Rated voltage	AC 230 V (±10%)
	Bemessungsfrequenz	50/60 Hz
	Power consumption	4 VA
	Fusing of supply lines	max. 10 AT
<b>Wiring of terminals</b>	(Power supply and outputs)	solid wire or stranded wire (twisted or with ferrule): 1 core: 0.5...2.5 mm <sup>2</sup> 2 cores 0.5...1.5 mm <sup>2</sup>
<b>Functional data</b>	Software class	A
	Mode of operation to EN 60 730	1b (automatic operation)
<b>Inputs</b>	Digital inputs H2	safety extra low-voltage for potentialfree low-voltage contacts: voltage with contact open: DC 12 V current with contact closed: DC 3 mA
	Analog input H2	protective extra low-voltage operating range: DC (0...10) V internal resistance: > 100 kΩ
	Mains input L	AC 230 V (±10 %) internal resistance: > 100 kΩ
	Sensor inputs BX6, BX7	NTC10k (QAZ36, QAD36)
	Perm. sensor cables (copper)	
	with cross-sectional area:	0.25 0.5 0.75 1.0 1.5 mm <sup>2</sup>
Max. length:	20 40 60 80 120 m	
<b>Outputs</b>	Relay outputs	
	Rated current range	AC 0.02...2 (2) A
	Max. switch-on current	15 A for ≤1 s
	Max. total current (of all relays)	AC 6 A
<b>Interfaces</b>	Rated voltage range	AC (24...230) V (for potentialfree outputs)
	BSB	2-wire connection, not interchangeable
	Max. cable length	
	Basic unit – peripheral device	200 m
	Max. total length	400 m (max. cable capacitance) 60 nF)
Min. cross-sectional area	0.5 mm <sup>2</sup>	

<b>Degree of protection and safety class</b>	Degree of protection of housing to EN 60 529	IP 00
	Safety class to EN 60 730	low-voltage-carrying parts meet the requirements of safety class II, if correctly installed
<b>Standards, safety, EMC, etc.</b>	Degree of pollution to EN 60 730	Normal pollution
	CE conformity to	
	EMC directive	89/336/EEC
	- Immunity	- EN 61000-6-2
	- Emissions	- EN 61000-6-3
<b>Climatic conditions</b>	Low-voltage directive	73/23/EEC
	- Electrical safety	- EN 60730-1, EN 60730-2-9
	Storage to IEC721-3-1 class 1K3	temp. -20...65 °C
<b>Weight</b>	Transport to IEC721-3-2 class 2K3	temp. -25...70°C
	Operation to IEC721-3-3 class 3K5	temp. 0...50 °C (noncondensing)
	Without packaging	293 g

### 8.3 Operator unit and room units AVS37... / QAA7x... / QAA55..

<b>Power supply</b>	For devices without batteries:	
	Bus power supply	BSB
	For devices with batteries:	
	Batteries	3 pcs
	Type of batteries	1.5 V Alkali size AA (LR06)
	Battery life	approx. 1.5 years
<b>Room temperature measurement (only with QAA7x...) / QAA55...</b>	Measuring range:	0...50 °C
	According to EN12098:	
	Range 15...25 °C range 0..15 °C or 25...50 °C resolution	within tolerance of 0.8 K within tolerance of 1.0 K 1/10 K
<b>Interfaces</b>	AVS37../QAA75../QAA55..	BSB-W, 2-wire connection, not interchangeable
	Max. cable length basic unit – peripheral device	QAA75../QAA55.. = 200 m AVS37.. = 3 m
	QAA78...	BSB-RF frequency band 868 MHz
<b>Degree of protection and safety class</b>	Degree of protection of housing to EN 60 529	IP20 for QAA7../ QAA55.. IP40 for AVS37... IP20 (when mounted)
	Safety class to EN 60 730	Normal pollution low-voltage-carrying parts meet the requirements of safety class III, if correctly installed
	Degree of pollution to EN 60 730	Normal pollution
<b>Standards, safety, EMC, etc.</b>	CE conformity to	
	EMC directive	89/336/EEC
	- Immunity	- EN 61000-6-2
	- Emissions	- EN 61000-6-3
	Low-voltage directive	73/23/EEC
<b>Climatic conditions</b>	- Electrical safety	- EN 60730-1, EN 50090-2-2
	Radio	EN 300 220-1 (25-1000MHz)
	For devices without batteries:	
	Storage to IEC721-3-1 class 1K3	temperature -20...65 °C
	Transport to IEC721-3-2 class 2K3	temperature -20...70 °C

	Operation to IEC721-3-3 class 3K5	temperature 0...50 °C (noncondensing)
	For devices with batteries:	
	Storage to IEC721-3-1 class 1K3	temperature -20...30 °C
	Transport to IEC721-3-2 class 2K3	temperature -20...70 °C
	Operation to IEC721-3-3 class 3K5	temperature 0...50 °C (noncondensing)
<b>Weight</b>	Without packaging	AVS37.294: 160 g QAA75.61x: 170 g QAA78.610: 312 g QAA55.110: 115 g

## 8.4 Power supply AVS16.290

<b>Power supply</b>	Nominal voltage	AC 230 V (±10 %)
	Nominal frequency	50 Hz
	Fuse	6.3 AT (5 x 20 mm)
	Power consumption	0,4 VA
	Fusing of supply lines	max. 10 A
<b>Functional data</b>	Switching capacity SLT	16 (12) A, AC 230V (+-10%), 50Hz
<b>Degree of protection and safety class</b>	Degree of protection of housing to EN 60 529	IP 40 (when mounted)
	Safety class to EN 60 730	corresponding to safety class II if adequately mounted
		Normal pollution
<b>Standards, safety</b>	Degree of pollution to EN 60 730	
	CE conformity to	
	low-voltage directive	73/23/EEC
	electrical safety	EN 60 730-1, EN 60 730-2-9
<b>Climatic conditions</b>	Storage to IEC721-3-1 class 1K3	temp. -20...65 °C
	Transport to IEC721-3-2 class 2K3	temp. -25...70°C
	Operation to IEC721-3-3 class 3K5	temp. 0...50 °C (noncondensing)
<b>Weight</b>	Without packaging	310 g

## 8.5 Radio module AVS71.390

<b>Power supply</b>	Via RVS... basic unit	DC 5.5 V
	Power consumption	max. 0.11 VA
<b>Interfaces</b>	Connection to RVS... basic units (power supply, communication)	6-pole prefabricated ribbon cable, ready fitted, 1.5 m 1.5m
	Radio transmitter	BSB-RF frequency band 868 MHz
<b>Degree of protection and safety class</b>	Degree of protection of housing to EN 60 529	IP40
	Safety class to EN 60 730	low-voltage-carrying parts meet the requirements of safety class III, if correctly installed
	Degree of pollution to EN 60 730	Normal pollution

<b>Standards, safety, EMC, etc.</b>	CE conformity to	
	EMC directive	89/336/EEC
	- Immunity	- EN 61000-6-1, EN 61000-6-2
	- Emissions	- EN 61000-6-3, EN 61000-6-4
	Low-voltage directive	73/23/EEC
	- Electrical safety	- EN 60730, EN 50090-2-2
	Radio	EN 300 220-1 , -3 (25-1000MHz) EN 301 489-1 , -3
<b>Climatic conditions</b>	Storage to EN 60721-3-1	class 1K3, temp. -20...65 °C
	Transport to EN 60721-3-2	class 2K3, temp. -25...70°C
	Operation to EN 60721-3-3	class 3K5, temp. 0...50°C (non-condensing)
<b>Weight</b>	Without packaging	54 g

## 8.6 Wireless outside sensor AVS13.399

<b>Power supply</b>	Batteries	2 pcs
	Type of batteries	1.5 V Alkali size AAA (LR03)
	Battery life	approx. 2 years
<b>Interfaces</b>	Radio transmitter	BSB-RF frequency band 868 MHz
	Degree of protection of housing to EN 60529	IP20
<b>Degree of protection and safety class</b>	Safety class to EN 60 730	low-voltage-carrying parts meet the requirements of safety class III, if correctly installed
	Degree of pollution to EN 60 730	Normal pollution
	CE conformity to	
<b>Standards, safety, EMC, etc.</b>	EMC directive	89/336/EEC
	- Immunity	- EN 61000-6-2
	- Emissions	- EN 61000-6-3
	Low-voltage directive	73/23/EEC
	- Electrical safety	- EN 60730-1, EN 50090-2-2
	Radio	EN 300 220-1 (25-1000MHz)
<b>Climatic conditions</b>	For devices without batteries:	
	Storage to IEC721-3-1 class 1K3	temperature -20...65 °C
	Transport to IEC721-3-2 class 2K3	temperature -20...70 °C
	Operation to IEC721-3-3 class 3K5	temperature 0...50 °C (noncondensing)
	For devices with batteries:	
	Storage to IEC721-3-1 class 1K3	temperature -20...30 °C
	Transport to IEC721-3-2 class 2K3	temperature -20...70 °C
Operation to IEC721-3-3 class 3K5	temperature 0...50 °C (noncondensing)	
<b>Outside temperature acquisition</b>	OutsideSens	QAC34/101
	Measuring range	-50...70 °C
	Cable length	max. 5 m
<b>Weight</b>	Without packaging	Radio transmitter 160 g Outside sensor QAC34 73 g Cable 70 g

## 8.7 Radio repeater AVS14.390

<b>Power supply</b>	Nominal voltage	AC 230 V $\pm$ 10 % (primary side AC/AC adapter)
	Nominal frequency	50 Hz $\pm$ 6 %
	Power consumption	max. 0.5 VA
<b>Interfaces</b>	Radio transmitter	BSB-RF frequency band 868 MHz
<b>Degree of protection and safety class</b>	Degree of protection of housing to EN 60529	IP20
	Safety class to EN 60 730	low-voltage-carrying parts meet the requirements of safety class III, if correctly installed
	Degree of pollution to EN 60 730	Normal pollution
<b>Standards, safety, EMC, etc.</b>	CE conformity to	
	EMC directive	89/336/EEC
	- Immunity	- EN 61000-6-2
	- Emissions	- EN 61000-6-3
	Low-voltage directive	73/23/EEC
- Electrical safety	- EN 60730-1, EN 50090-2-2	
	Radio	EN 300 220-1 (25-1000MHz)
<b>Climatic conditions</b>	Storage to IEC721-3-1 class 1K3	temp. -20...65 °C
	Transport to IEC721-3-2 class 2K3	temp. -25...70°C
	Operation to IEC721-3-3 class 3K5	temp. 0...50 °C (noncondensing)
<b>Weight</b>	Without packaging	Radio repeater 112 g Power supply 195 g



## 8.8 Sensor characteristics

### 8.8.1 NTC 1 k

T [°C]	R[Ohm]	T [°C]	R[Ohm]	T [°C]	R[Ohm]
-30.0	13,034	0.0	2,857	30.0	827
-29.0	12,324	1.0	2,730	31.0	796
-28.0	11,657	2.0	2,610	32.0	767
-27.0	11,031	3.0	2,496	33.0	740
-26.0	10,442	4.0	2,387	34.0	713
-25.0	9,889	5.0	2,284	35.0	687
-24.0	9,369	6.0	2,186	36.0	663
-23.0	8,880	7.0	2,093	37.0	640
-22.0	8,420	8.0	2,004	38.0	617
-21.0	7,986	9.0	1,920	39.0	595
-20.0	7,578	10.0	1,840	40.0	575
-19.0	7,193	11.0	1,763	41.0	555
-18.0	6,831	12.0	1,690	42.0	536
-17.0	6,489	13.0	1,621	43.0	517
-16.0	6,166	14.0	1,555	44.0	500
-15.0	5,861	15.0	1,492	45.0	483
-14.0	5,574	16.0	1,433	46.0	466
-13.0	5,303	17.0	1,375	47.0	451
-12.0	5,046	18.0	1,320	48.0	436
-11.0	4,804	19.0	1,268	49.0	421
-10.0	4,574	20.0	1,218	50.0	407
-9.0	4,358	21.0	1,170		
-8.0	4,152	22.0	1,125		
-7.0	3,958	23.0	1,081		
-6.0	3,774	24.0	1,040		
-5.0	3,600	25.0	1,000		
-4.0	3,435	26.0	962		
-3.0	3,279	27.0	926		
-2.0	3,131	28.0	892		
-1.0	2,990	29.0	859		

### 8.8.2 NTC 10 k

T [°C]	R[Ohm]	T [°C]	R[Ohm]	T [°C]	R[Ohm]
-30.0	175203	50.0	3605	130.0	298
-25.0	129289	55.0	2989	135.0	262
-20.0	96360	60.0	2490	140.0	232
-15.0	72502	65.0	2084	145.0	206
-10.0	55047	70.0	1753	150.0	183
-5.0	42158	75.0	1481	155.0	163
0.0	32555	80.0	1256	160.0	145
5.0	25339	85.0	1070	165.0	130
10.0	19873	90.0	915	170.0	117
15.0	15699	95.0	786	175.0	105
20.0	12488	100.0	677	180.0	95
25.0	10000	105.0	586	185.0	85
30.0	8059	110.0	508	190.0	77
35.0	6535	115.0	443	195.0	70
40.0	5330	120.0	387	200.0	64
45.0	4372	125.0	339		

### 8.8.3 PT1000

T [°C]	R[Ohm]	T [°C]	R[Ohm]	T [°C]	R[Ohm]
-30	882.2	50	1194.0	130	1498.3
-25	901.9	55	1213.2	135	1517.1
-20	921.6	60	1232.4	140	1535.8
-15	941.2	65	1251.6	145	1554.6
-10	960.9	70	1270.8	150	1573.3
-5	980.4	75	1289.9	155	1591.9
0	1000.0	80	1309.0	160	1610.5
5	1019.5	85	1328.0	165	1629.1
10	1039.0	90	1347.1	170	1647.7
15	1058.5	95	1366.1	175	1666.3
20	1077.9	100	1385.1	180	1684.8
25	1097.3	105	1404.0	185	1703.3
30	1116.7	110	1422.9	190	1721.7
35	1136.1	115	1441.8	195	1740.2
40	1155.4	120	1460.7	200	1758.6
45	1174.7	125	1479.5		

Index	
<b>2</b>	
24-hour heating limit .....	68
2nd pump speed .....	94
<b>A</b>	
<b>Absolute priority</b> .....	84
Acknowledgements .....	109
Action changeover functions .....	107
Action of operation .....	64
Actuator running time .....	74
Adaption .....	68
Alarm output K10 .....	94
Alarm signal .....	94
Applications .....	117
Assignment device 1 .....	64
Assignment of DHW heating .....	108
<b>B</b>	
Basic diagrams .....	117
Boost heating .....	71
Buffer storage tank function .....	76, 83, 86, 91
Building and room model .....	103
Bus power supply function .....	106
Bus power supply state .....	106
<b>C</b>	
Changeover of operating mode .....	96
Charging control .....	89
Charging controller (dT) .....	87
Charging temperature max .....	89
Check-No. heat source 1 .....	105
Check-No. heating circuit .....	105
Check-No. storage tank .....	105
Chimney sweep function .....	36, 55
Circulating pump cycling .....	85
Circulating pump release .....	85
Clock mode .....	108
Collector frost protection .....	87
Collector overtemp prot. ....	88
Collector pump	
min run time .....	87
Collector pump Q5 .....	94
Comfort setpoint .....	67
Commissioning .....	31
Compensation variants .....	80
Configuration .....	92
Construction .....	103
Control thermostat .....	93
Cooling mode .....	34, 60
Curing heating .....	75
<b>D</b>	
Date .....	62
Default settings .....	66
Default values .....	66
Device address .....	106
Device data .....	106
Device version .....	64
Dewpoint monitoring .....	81
DHW actuating device Q3 .....	93
DHW assignment .....	107
DHW circulating pump .....	94
DHW circulating pump Q4 .....	94
DHW electric immersion heater .....	94
DHW electric immersion heater K6 .....	94
DHW request .....	89
DHW sensor B3 .....	93
<b>E</b>	
ECO functions .....	68
EI imm heater optg mode .....	90
EI immersion heater control .....	90
EI immersion heater release .....	90
Electric immersion heater .....	90
Error history .....	109
Evaporation heat carrier .....	88
<b>F</b>	
Faults .....	109
Floor curing function .....	75
<b>Floor curing heating</b> .....	75
Floor curing setp manually .....	75
Floor heating .....	75
Flow setpoint boost .....	89
Flow temp setpoint max .....	70
Flow temp setpoint min .....	69
Flow temperature setpoint limitations .....	79
Flow temperature setpoint limits .....	69
Frost protection .....	67
Frost protection plant .....	103
Frost protection setpoint .....	67
Function extension module 1 .....	18
Functional check .....	31
Functional heating .....	75
<b>G</b>	
Generation lock .....	107
<b>H</b>	
H1/H2/H3 prim contr/system pump .....	86
H1/H2/H3 with storage buffer tank .....	86
Heat generation lock .....	96
Heating circuit pump 2 .....	94
Heating circuit pump HCP Q20 .....	94
Heating curve .....	67
Heating curve adaption .....	67, 68
Heating curve displacement .....	67, 68
Heating curve slope .....	67
Heating curve slope .....	67
Heating curve slope .....	67
Holiday program .....	66
Holidays	
end .....	66
start .....	66
<b>I</b>	
Input / output test .....	111

Input test sensor .....	111
<b>L</b>	
Language .....	62
Legionella funct	
Circ pump .....	85
Legionella funct duration .....	85
Legionella funct periodically .....	85
Legionella funct setpoint .....	85
Legionella funct time .....	85
Legionella funct weekday .....	85
Legionella function .....	85
<b>M</b>	
Maintenance / special mode .....	109
Manual operation .....	110
Min flow temp setpoint H. ....	98
Minimum flow temperature setpoint TVHw .....	96
Mixing valve boost .....	74
Mixing valve control .....	74
Mixing valve control cooling .....	81
Monitor	
Dewpoint .....	81
<b>N</b>	
<b>No priority</b> .....	85
<b>O</b>	
Operating level .....	66
Operating mode .....	77
Heating circuits .....	66
Operating mode changeover .....	107
Operation lock .....	62
Optg mode changeover .....	76
Optimum start / stop control .....	73
Optimum start control max .....	73
Optimum stop control max .....	73
Outside sensor readjustment .....	103
Outside temp source .....	108
Outside temperature simulation .....	110
Overtemp prot pump circuit .....	74
Overtemperature protection .....	89
<b>P</b>	
Parallel displacement .....	68
Plant diagram .....	105
Plant diagrams .....	117
Pressure measurement 10V .....	97
programming lock .....	62
Protection mode .....	67
Protective collector overtemperature function .....	89
Pump H1 .....	94
Pump H1 Q15 .....	94
Pump H2 .....	95
Pump heating circuit .....	71
Pure room compensation .....	70, 80
Pure weather compensation .....	70
<b>Q</b>	
Quick setback .....	72

<b>R</b>	
Radio .....	65
binding .....	65
Test mode .....	65
Raising the reduced setpoint .....	73
Readjustment room sensor .....	64
Recooling boiler/HC .....	89
Recooling collector .....	89
Recooling temperature .....	89
Red setpoint increase end .....	73
Red setpoint increase start .....	73
Reduced setpoint .....	67
Reference room .....	70, 80
Refrigeration demand .....	98
Relay output QX1, 2, 3, 4 .....	93
Release cooling circuit .....	77
Reset .....	36
Reset alarm relay .....	109
Reset to default parameters .....	105
Room influence .....	70, 80
Room temp limitation .....	71
Room temperature .....	67
Room temperature limitation cooling .....	80
<b>S</b>	
Save sensors .....	104, 105
Segment address .....	106
Sensor input BX1, 2, 3, 4 .....	95
Sensor readjustments .....	103
Sensor state .....	105
Sensor test .....	111
Setpoints .....	67
<b>Shifting priority</b> .....	84
Simulation outside temp .....	110
<b>Simulations</b> .....	110
SLT test .....	36
Software version .....	106
Solar .....	87
Summer changeover .....	107
Summer compensation .....	78
Summer/winter heating limit .....	68
Summertime .....	62
Switching points .....	66
Switching times .....	65
<b>T</b>	
Telephone customer service .....	111
Temperature alarms .....	109
Temperature difference	
Collector .....	87
Thermostatic radiator valves .....	70, 71
Time constant building .....	103
Time of day .....	62
Time programs .....	65
Transfer boost .....	89
Type of charging .....	89
Types of compensation .....	70

**W**

Weather compensation .....	80	Weekday .....	62
Weather compensation only .....	80	Wintertime .....	62
Weather compensation with room influence .....	70, 80	With buffer storage tank .....	76, 91
		With prim contr/system pump .....	91

## 9 Revision history

All changes made to the document since the last issue (see front page) are identified with the Winword function "Highlight". To show such text, use the following key combinations:

Display: Ctrl Shift (Num) +

Hide: Ctrl Shift (Num) -

Or select the same functionality with the following Winword menu:

Menu: [Tools] - [Options]

Command: [Highlight]



The revision history is not visible in the print file (PDF).

Siemens Switzerland Ltd  
Building Technologies Group / HVAC Products  
Gubelstrasse 22  
CH -6301 Zug  
Tel. +41 41-724 24 24  
Fax +41 41-724 35 22  
[www.sbt.siemens.com](http://www.sbt.siemens.com)

© 2005-2007 Siemens Building Technologies Ltd.  
Subject to change