



Residential Air damper actuators

GXD..31.1

Rotary version, three-position control

Electric motor-driven actuators for three-position control
1.5 Nm nominal torque
AC 24 V or AC 230 V rated voltage

Use

In ventilating and air conditioning plants to actuate air dampers

- with nominal torque of 1.5 Nm for damper areas of approx. up to 0.3 m² or barrel dampers up to 12".
- operate direct driven zone dampers used to control air flow in ducts
- specifically to address domestic and light commercial barrel damper applications



Type Summary

Non-spring return -
rotary air damper
actuators

Type	Operating Voltage	Operating Frequency	Control signal	Torque	Cable length	Coupling
GXD131.1A	24 VAC	50/60 Hz	3-Position	1.5 Nm	0.9 m	Φ 8 Round
GXD131.1K	24 VAC	50/60 Hz	3-Position	1.5 Nm	Modular Jack	Φ 8 Round
GXD331.1A	230 VAC	50 Hz	3-Position	1.5 Nm	0.9 m	Φ 8 Round

Connecting cables

The actuator comes with 0.9 m long pre-wired connecting cables, except GXD131.1K with RJ11 Modular Jack

Equipment Combinations	These actuators can be connected to all control devices with a three-position output supplying a switching voltage of AC 24 V or AC 230 V.
Functions	
Basic Functions	
Rotational movement	The actuators rotational movement (clockwise or counter-clockwise) depends on the electrical control. As soon as the operating voltage AC 24 V or AC 230 V is applied, the actuator starts to turn.
Three-position control	The connected damper can be operated as follows via the respective actuator control. Example: clockwise direction <ul style="list-style-type: none"> • Damper opens (0 °...90 °) • Damper closes (90 °...0 °) With no power applied, the damper remains in the respective position.
Mechanical design	
Basic Components	
Housing	Robust, light-weight plastic housing.
Gear Train	Maintenance-free and low-noise gear train with metal gear train plate to extend actuator life.
Engineering notes	
STOP	The basic system data for the control systems in use contain all engineering information; refer to this data prior to mounting, wiring and commissioning the actuator and carefully read all safety information.
Intended use	Use these actuators in a system only for applications as described in the basic system documentation of the applied control systems. Additionally, include all actuator-specific features and conditions as described in the brief description on the title page of this data sheet (bold print) and in the chapters "Use", "Engineering Notes" and "Technical Data".
	The sections flagged with a warning symbol as illustrated in the left margin contain safety-related requirements and restrictions. It is important that these are adhered in order to prevent physical injury and equipment damage.
AC 24 V supply	Operate the actuators only on safety extra-low voltage (SELV) or protection by extra low voltage (PELV) as per HD 384.
 AC 230 V supply	The actuators are double - insulated and do not provide a connection for the protective ground.
CAUTION	Do not open the actuator! <ul style="list-style-type: none"> • The units are maintenance-free. • Any repair work must be conducted by the manufacturer only. • Opening of the actuator will void warranty.
Parallel connection	Parallel connection of GXD actuators is not permitted.

Required actuator type

Selection of the actuator depends on several torque factors. After obtaining the damper torque rating (Nm/m²) from the manufacturer and determining the damper area, calculate the torque total required to move the damper as follows:

IF total torque (SF ¹)	Use type
≤ 2 Nm	GXD...1 (1.5 Nm)
≤ 5 Nm	GDB...1 (5 Nm)
≤ 10 Nm	GLB...1 (10 Nm)
≤ 15 Nm	GEB...1 (15 Nm)
≤ 25 Nm	GBB...1 (25 Nm)
≤ 35 Nm	GIB... 1 (35 Nm)

¹ Safety factor SF: When calculating the number of actuators, non-definable variables such as slight misalignment, damper age, etc. must be included as a safety factor. We recommend a safety factor of 0.80 (or 80% of the torque characteristic)

Sizing transformers for AC 24 V (SELV)

Use safety insulating transformers with double insulation as per EN 60 742; the transformers must be made for 100% runtime.

Observe all local safety rules and regulations pertaining to sizing and protection of transformers.

Determine the transformer's power consumption by adding up the power consumption in VA for all actuators used.

Wiring and commissioning

Refer to "Commissioning notes" and "Diagrams" in this data sheet as well as to the HVAC job drawings.

Mounting notes

Mounting instructions

All information and steps to properly prepare and mount the actuator are listed in the Mounting instruction guide supplied with the actuator.

Mounting position

Choose the actuators mounting position so that it is easy to access the cables as well as the setting shaft on the actuator front. Refer to "Dimensions".

Damper shafts

Information on minimum length and diameter for the damper shaft is available in "Technical data".

Commissioning Notes

References

For commissioning, the following reference documentation must exist:

- This data sheet: HK3N4622en
- Mounting instructions: HK3M4622en
- Job diagram

Ambient conditions

Check to ensure that all permissible values as contained in the "Technical data" have been observed.

Mechanical check: Check for proper mounting and ensure that all mechanical settings correspond to the plant-specific requirements. Additionally, ensure that the dampers are shut tight when in the closed position.

Check the direction of rotation.

Fasten the actuator securely to avoid twisting and blocking of the actuator.

Electrical check

Check to ensure that the cables are connected in accordance with the plant wiring diagram (see "Diagrams").

The operating voltage AC 24 V or AC 230 V (SELV/PELV) must be within the tolerance values.

Functional check:

Control signal AC 24 V

- Between wires red-violet : actuator turns clockwise.
- Between wires red-orange : actuator turns counter-clockwise.

Control signal AC 24 V (RJ11 type)

- Connection between Pin 3 / 4 - Pin 1 / 2: actuator turns clockwise.
- Connection between Pin 3 / 4 - Pin 5 / 6: actuator turns counter-clockwise.

Control signal AC 230 V

- Between wires light blue-black : actuator turns clockwise.
- Between wires light blue-white : actuator turns counter-clockwise.

The actuator remains in the current position if no control signal is applied.

Technical Data

Power supply AC 24 V for GXD131.1A / 131.1K	Operating voltage	AC 24 V \pm 15 %	
	Supply line fuse	Max. 10 A	
	Frequency	50/60 Hz	
	Power supply (with control signal)	180 mA	
	Power supply (with control signal)	4.3 VA / 5 W	
 Power supply AC 230 V for GXD331.1A	Operating voltage	AC 230 V \pm 15 %	
	Safety extra-low (SELV) or Protection by extra-low voltage (PELV) as per	HD 384	
	Requirements of external safety insulating transformer (100 % ED)	EN 60 730-1	
	Supply line fuse	Max. 10 A	
	Frequency	50 Hz	
	Power supply (with control signal)	20 mA	
	Power supply (with control signal)	5 VA / 5 W	
	Mechanical data	Torque GXD..3..1A	
		Nominal torque	1.5 Nm
		Minimum holding torque (with/without operating voltage)	>2 Nm
Maximum torque		< 2 Nm \pm 10 %	
Nominal rotational angle		90 °	
Maximum rotational angle (mechanic limitation)		< 95 °	
Run time for nominal rotational angle 90 °, motor operation at 50/60 Hz		15 Seconds \pm 2 Seconds (@ 60 Hz) 19 Seconds \pm 2 Seconds (@ 50 Hz)	
Duty cycle		One cycle per minute	
Rotational movement direction		Clockwise / Counter-clockwise	
Mechanical life		On / Off 25,000 cycles	
Wire connections	Control signals AC 230 V		
	Wires light blue – black	Clockwise	
	Wires light blue – white	Counter-clockwise	
	Control signals AC 24 V		
	Wires red-violet	Clockwise	
	Wires red-orange	Counter-clockwise	
	Control signals AC 24 V (RJ11 type)		
	Wires green / red – black / white	Clockwise	
	Wires green / red – blue / yellow	Counter-clockwise	
	Cable Lengths	0.9 m	

Housing Protection	Supply AC 24 V (red, violet, orange)	3 x 0.75 mm ²
	AC 230 V (light blue, white black)	3 x 0.75 mm ²
	Degree of protection as per EN 60 529	IP40
	Insulation class	
Environmental Conditions	AC 230 V	II
	AC 24 V	III
	Operation	IEC 721-3-3
	Climatic conditions	Class 3K5
	Mounting location	interior, weather-protected
	Temperature	0..+60 °C
	Humidity (non-condensing)	< RH 95 %
	Transport	IEC 721-3-2
	Climatic conditions	Class 2K2
	Temperature	-32...+70 °C
Humidity (non-condensing)	< 95% r.h.	
Standards	Mechanical conditions	Class 2M3
	Product Safety	
	Automatic electrical controls for household and similar use	EN 60730-2-14 (Type 1)
	Electromagnetic compatibility (Application)	For residential, commercial and industrial environments
	EU Conformity (CE)	A5W00004360 ¹⁾
	RCM Conformity	A5W00004361 ¹⁾
Dimensions	Product environmental declaration ²⁾	CM2E4604E ¹⁾
	Actuator	
	W × H × D	70 × 65 × 100
	Damper shaft	
	Round	8.0 mm ± 0.1 mm
Inner round	6.3 mm ± 0.1 mm	
Min length	30 mm	
Max shaft hardness	260 HB	
Weight	Without packaging	0.58 Kg

¹⁾ The documents can be downloaded from <http://siemens.com/bt/download>

²⁾ The product environmental declaration contains data on environmentally compatible product design and assessments (RoHS compliance, materials composition, packaging, environmental benefit, disposal).

Disposal



The device is considered an electronics device for disposal in terms of European Directive 2012/19/EU and may not be disposed of as domestic garbage.

- Dispose of the device through channels provided for this purpose.
- Comply with all local and currently applicable laws and regulations.

Connection Diagram

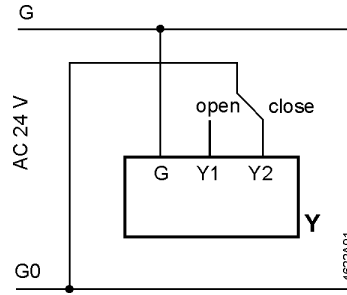

- Y Damper actuator
GXD131.1A
- G red
- Y1 violet
- Y2 orange
- G System potential AC 24 V
- G0 System, neutral

Configuration of RJ11 Modular Jack of GXD131.1K

- 1: Black
- 2: White
- 3: Green
- 4: Red
- 5: Blue
- 6: Yellow

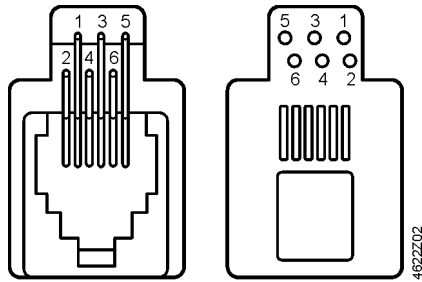

- Damper actuator
GXD131.1K
- AC 24 V / 50 Hz
- Refer to configuration of RJ11
Modular Jack of GXD131.1K

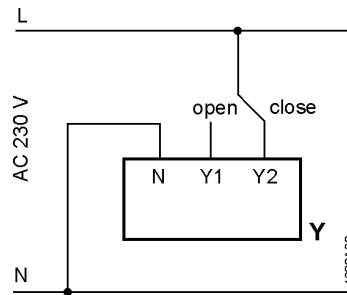

- Y Damper actuator
GXD331.1A
- N Light blue
- Y1 black
- Y2 white
- L System potential
AC 230 V
- N System, neutral

Dimensions

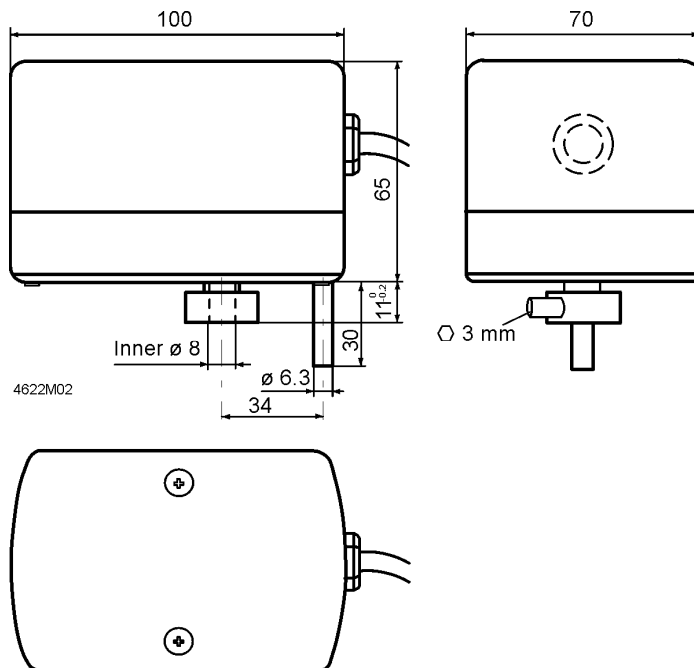

Issued by
Siemens Switzerland Ltd
Building Technologies Division
International Headquarters
Gubelstrasse 22
6301 Zug
Switzerland
Tel. +41 41-724 24 24
www.siemens.com/buildingtechnologies

© Siemens Switzerland Ltd, 2002
Technical specifications and availability subject to change without notice.